



Main catalog

# Motor protection and control

## Manual motor starters, A9 ... A300 contactors and overload relays

# Motor rated operational powers and currents

The currents given below concern standard three-phase four-pole cage motors (1500 r.p.m. at 50 Hz 1800 r.p.m. at 60 Hz). These values are given for guidance and may vary according to the motor manufacturer and depending on the number of poles.

IEC	Motor nominal current: standardized values in blue colour (according to IEC 60947-4-1 Annex G)									
Motor power kW	220 V A	230 V A	240 V A	380 V A	400 V A	415 V A	440 V A	500 V A	660 V A	690 V A
0.06	0.37	0.35	0.34	0.21	0.2	0.19	0.18	0.16	0.13	0.12
0.09	0.54	0.52	0.50	0.32	0.3	0.29	0.26	0.24	0.18	0.17
0.12	0.73	0.7	0.67	0.46	0.44	0.42	0.39	0.32	0.24	0.23
0.18	1	1	1	0.63	0.6	0.58	0.53	0.48	0.37	0.35
0.25	1.6	1.5	1.4	0.9	0.85	0.82	0.74	0.68	0.51	0.49
0.37	2.0	1.9	1.8	1.2	1.1	1.1	1	0.88	0.67	0.64
0.55	2.7	2.6	2.5	1.6	1.5	1.4	1.3	1.2	0.91	0.87
0.75	3.5	3.3	3.2	2.0	1.9	1.8	1.7	1.5	1.15	1.1
1.1	4.9	4.7	4.5	2.8	2.7	2.6	2.4	2.2	1.7	1.6
1.5	6.6	6.3	6	3.8	3.6	3.5	3.2	2.9	2.2	2.1
2.2	8.9	8.5	8.1	5.2	4.9	4.7	4.3	3.9	2.9	2.8
3	11.8	11.3	10.8	6.8	6.5	6.3	5.7	5.2	4	3.8
4	15.7	15	14.4	8.9	8.5	8.2	7.4	6.8	5.1	4.9
5.5	20.9	20	19.2	12.1	11.5	11.1	10.1	9.2	7	6.7
7.5	28.2	27	25.9	16.3	15.5	14.9	13.6	12.4	9.3	8.9
11	39.7	38	36.4	23.2	22	21.2	19.3	17.6	13.4	12.8
15	53.3	51	48.9	30.5	29	28	25.4	23	17.8	17
18.5	63.8	61	58.5	36.8	35	33.7	30.7	28	22	21
22	75.3	72	69	43.2	41	39.5	35.9	33	25.1	24
30	100	96	92	57.9	55	53	48.2	44	33.5	32
37	120	115	110	69	66	64	58	53	40.8	39
45	146	140	134	84	80	77	70	64	49.1	47
55	177	169	162	102	97	93	85	78	59.6	57
75	240	230	220	139	132	127	116	106	81	77
90	291	278	266	168	160	154	140	128	97	93
110	355	340	326	205	195	188	171	156	118	113
132	418	400	383	242	230	222	202	184	140	134
160	509	487	467	295	280	270	245	224	169	162
200	637	609	584	368	350	337	307	280	212	203
250	782	748	717	453	430	414	377	344	261	250
315	983	940	901	568	540	520	473	432	327	313
355	1109	1061	1017	642	610	588	535	488	370	354
400	1255	1200	1150	726	690	665	605	552	418	400
500	1545	1478	1416	895	850	819	745	680	515	493
560	1727	1652	1583	1000	950	916	832	760	576	551
630	1928	1844	1767	1116	1060	1022	929	848	643	615
710	2164	2070	1984	1253	1190	1147	1043	952	721	690
800	2446	2340	2243	1417	1346	1297	1179	1076	815	780
900	2760	2640	2530	1598	1518	1463	1330	1214	920	880
1000	3042	2910	2789	1761	1673	1613	1466	1339	1014	970

UL / CSA	Motor nominal current: standardized values (according to IEC 60947-4-1 Annex G and UL 508)				
Motor power hp	208 V A	220-240 V A	380-415 V A	440-480 V A	550-600 V A
1/2	2.4	2.2	1.3	1.1	0.9
3/4	3.5	3.2	1.8	1.6	1.3
1	4.6	4.2	2.3	2.1	1.7
1-1/2	6.6	6	3.3	3	2.4
2	7.5	6.8	4.3	3.4	2.7
3	10.6	9.6	6.1	4.8	3.9
5	16.7	15.2	9.7	7.6	6.1
7-1/2	24.2	22	14	11	9
10	30.8	28	18	14	11
15	46.2	42	27	21	17
20	59.4	54	34	27	22
25	74.8	68	44	34	27
30	88	80	51	40	32
40	114	104	66	52	41
50	143	130	83	65	52
60	169	154	103	77	62
75	211	192	128	96	77
100	273	248	165	124	99
125	343	312	208	156	125
150	396	360	240	180	144
200	528	480	320	240	192
250	-	604	403	302	242
300	-	722	482	361	289
350	-	828	560	414	336
400	-	954	636	477	382
450	-	1030	-	515	412
500	-	1180	786	590	472

# Motor protection and control

## Manual motor starters, contactors and overload relays

Overview

1

Manual motor starters

2

A contactors and N contactor relays

3

Thermal overload relays

4

General technical data

5

Index

6

You can access to more product details, click on the order code

**A9 ... A16 3-pole contactors**  
4 to 7.5 kW  
AC operated

**Description**  
A9 ... A16 contactors are mainly used for controlling 3-phase motors and power circuits up to 690 V AC or 220 V DC.  
These contactors are of the block type design with:  
- 3 main poles and 1 built-in auxiliary contact  
- control circuit: AC operated  
- add-on auxiliary contact blocks for front or side mounting and a wide range of accessories.

**Ordering details**

EC	UL/CSA	Rated control circuit voltage (Uc)	Auxiliary contacts (front)	Type	Order code	Weight (kg)
4	25	5	21	24	24	
		48	48			
		110	110	120		
		220-230	220-240			
		230-240	240-240			
		380-400	400-215			
		400-415	416-440			

Order codes:  
1SBL141001R8110  
1SBL141001R8101  
1SBL141001R8310  
1SBL141001R8301  
1SBL141001R8310  
1SBL141001R8301

Connect to

**Block Contactors**

Overview | Data | Contacts

**A9-30-10 48V 50Hz / 48V 60Hz**

[Print View](#)  
[Print to Pdf](#)  
[Downloads](#)

**General Information**

**Extended Product Type:** A9-30-10 48V 50Hz / 48V 60Hz  
**Product ID:** 1SBL141001R8310  
**EAN:** 3471522031639  
**Catalog Description:** A9-30-10 48V 50Hz / 48V 60Hz Contactor  
**Long Description:** A 9 contactors are mainly used for controlling 3-phase motors and generally for controlling power circuits up to 690 V AC or 220 V DC. The contactors can also be used for many other applications such as isolation, capacitor switching, lighting.  
The A... series 1-stack 3-pole contactors are of the block type design.  
- Main poles and auxiliary contact blocks: 3 main poles, 1 built-in auxiliary contact, front and side-mounted add-on auxiliary contact blocks  
- Control circuit: AC operated with laminated magnet circuit  
- Accessories: a wide range of accessories is available.

# 3-pole contactors, for motor control and power switching

1



<b>IEC (1)</b>	<b>AC-3 Rated operational power</b>	$\theta \leq 55^\circ\text{C}$ , 400 V	<b>kW</b>	<b>4</b>	<b>5.5</b>	<b>7.5</b>	<b>11</b>	<b>15</b>	<b>18.5</b>
<b>UL/CSA</b>	<b>3-phase motor rating</b>	480 V	<b>hp</b>	<b>5</b>	<b>7.5</b>	<b>10</b>	<b>20</b>	<b>25</b>	<b>30</b>
<b>AC Control supply</b>		Type		<b>A9</b>	<b>A12</b>	<b>A16</b>	<b>A26</b>	<b>A30</b>	<b>A40</b>
<b>IEC</b>	<b>AC-3 Rated operational current</b>	$\theta \leq 55^\circ\text{C}$ , 400 V	<b>A</b>	<b>9</b>	<b>12</b>	<b>17</b>	<b>26</b>	<b>32</b>	<b>37</b>
	<b>AC-1 Rated operational current</b>	$\theta \leq 40^\circ\text{C}$ , 690 V	<b>A</b>	<b>25</b>	<b>27</b>	<b>30</b>	<b>45</b>	<b>55</b>	<b>60</b>
<b>UL/CSA</b>	<b>General use rating</b>	600 V	<b>A</b>	<b>21</b>	<b>25</b>	<b>30</b>	<b>40</b>	<b>50</b>	<b>60</b>
<b>NEMA</b>	<b>NEMA Size</b>			<b>00</b>	<b>0</b>	<b>—</b>	<b>1</b>	<b>1P</b>	<b>—</b>

(1) 1000 V IEC ratings available for A50 ... A300 contactors.

## Main accessories

<b>Auxiliary contact blocks</b>	Front mounting	<b>CA5-10</b> (1 x N.O.) <b>CA5-01</b> (1 x N.C.)
	Side mounting	<b>CAL5-11</b> (1 x N.O. + 1 x N.C.)
<b>Timers</b>	Electronic	<b>TEF5-ON</b> <b>TEF5-OFF</b> <b>TE5S</b> (for star-delta starters - direct timing - separate mounting)
		<b>VM5-1</b>
		<b>VE5-1</b>
<b>Interlocking units</b>	Mechanical	<b>RV5</b> (24...440 V) <b>RC5-1</b> (24...440 V)
	Mechanical / Electrical	
<b>Surge suppressors</b>	Varistor (AC/DC)	
	RC Type (AC)	

## Overload relays

	<b>Thermal relays</b>	Class 10A (Class 10A or 20 for TA80DU) (Class 30 for TA450SU)	<b>TA25DU-M</b> (0.10...32 A)	<b>TA42DU-M</b> (18...42 A)
--	-----------------------	---	-------------------------------	-----------------------------

## Manual motor starters

	Thermal / magnetic protection Class 10	<b>MS116</b> (0.10...32 A) lcs up to 50 kA for class 10 A	<b>MS450</b> (28...50 A) lcs up to 50 kA
	Magnetic only types	<b>MS132</b> (0.10...32 A) lcs up to 100 kA	<b>MS497</b> (22...100 A) lcs up to 100 kA
		<b>MO132</b> (0.16...32 A) lcs up to 100 kA	<b>MO496</b> (32...100 A) lcs up to 100 kA
			<b>MO450</b> (40...50 A) lcs up to 50 kA

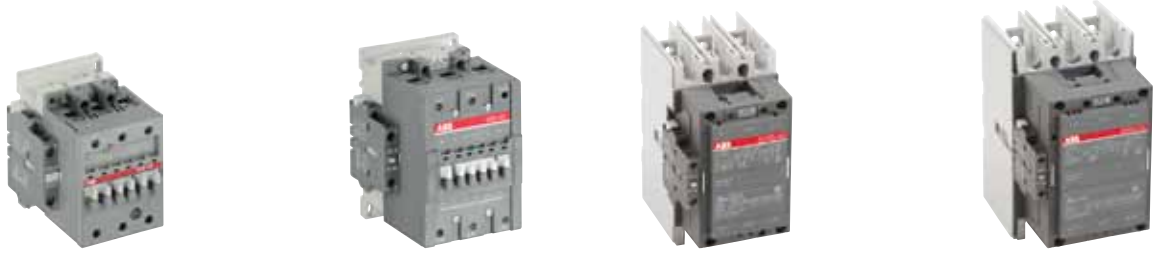

22	30	37	45	55	75	90	110	140	160
40	60	60	60	75	100	125	150	200	250
<b>A50</b>	<b>A63</b>	<b>A75</b>	<b>A95</b>	<b>A110</b>	<b>A145</b>	<b>A185</b>	<b>A210</b>	<b>A260</b>	<b>A300</b>
50	65	75	96	110	145	185	210	260	305
100	115	125	145	160	250	275	350	400	500
80	90	105	125	150	230	250	300	350	400
2	—	3	—	—	4	—	—	5	—

		<b>CAL18-11</b> (1 x N.O. + 1 x N.C.)	
<b>VE5-2</b>		<b>VM300H</b> <b>VM300V</b>	
<b>RC5-2</b> (24...440 V)		<b>RC5-3</b> (250...440 V)	

<b>TA75DU-M</b> (18...80 A)	<b>TA80DU</b> (29...80 A) <b>TA110DU</b> (66...110 A)	<b>TA200DU</b> (66...200 A)	<b>TA450DU</b> (130...310 A) <b>TA450SU</b> (40...310 A)
-----------------------------	--	-----------------------------	---

### Short-circuit protection devices

Tmax Circuit breaker and accessories

<b>MS495</b> (45...100 A) Ics up to 50 kA	<b>MO495</b> (63...100 A) Ics up to 50 kA
--	--



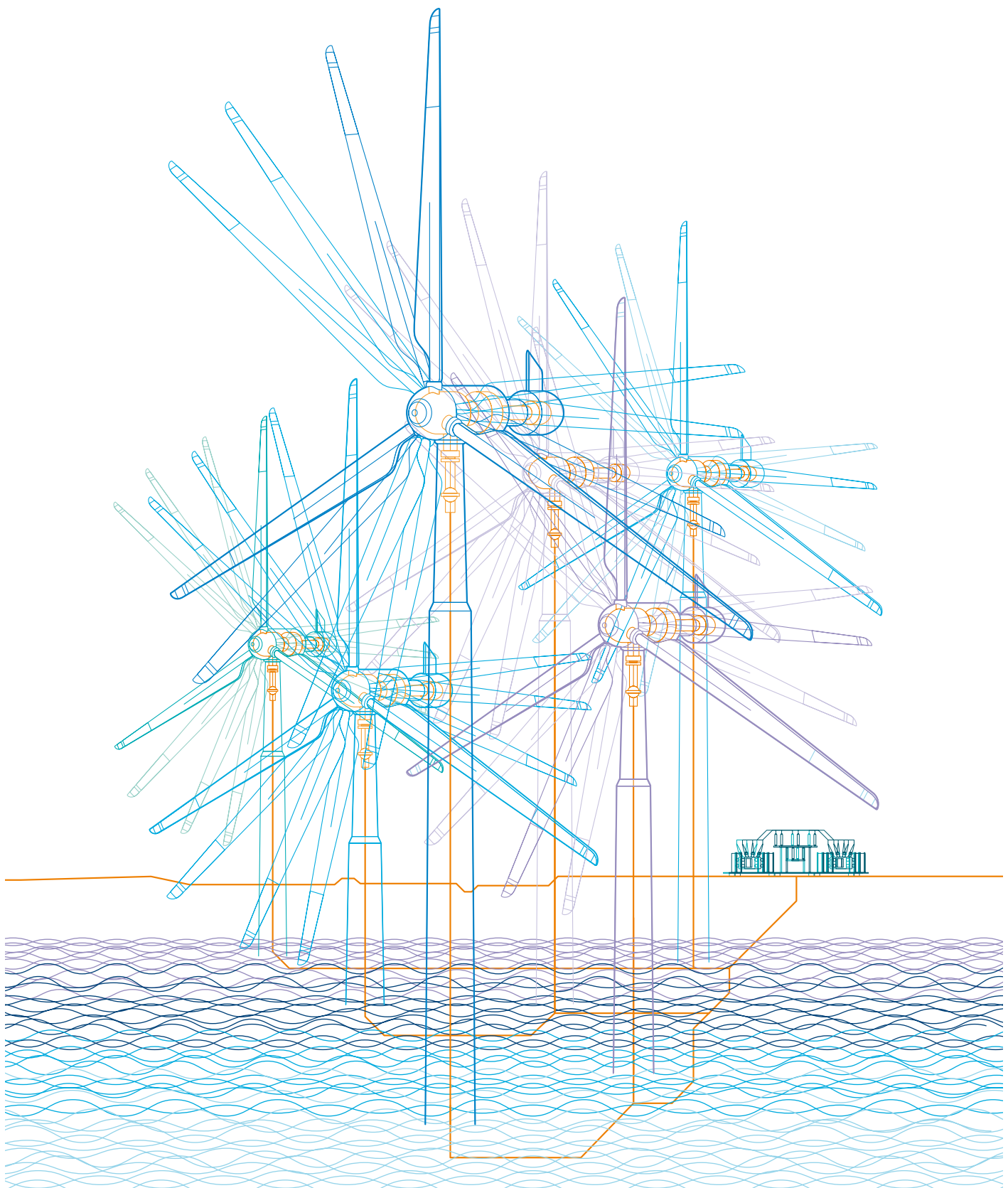

# 4-pole contactors



IEC	AC-1 Rated operational current	$\theta \leq 40\text{ }^\circ\text{C}$ , 690 V	A	25	30	45	70	100	125
UL/CSA	General use rating	600 V	A	21	30	40	65	80	105
<b>AC Control supply</b>			Type	A9	A16	A26	A45	A50	A75
IEC	AC-1 Rated operational current	$\theta \leq 40\text{ }^\circ\text{C}$	A	25	30	45	70	100	125
		$\theta \leq 55\text{ }^\circ\text{C}$	A	22	27	40	60	85	105
		$\theta \leq 70\text{ }^\circ\text{C}$	A	18	23	32	50	70	85
	With conductor cross sectional area		mm <sup>2</sup>	2.5	4	6	25	35	50
	Rated operational voltage Ue max.		V	690	690	690	1000	1000	1000

## Main accessories

<b>Auxiliary contact blocks</b>	Front mounting	CA5-10 (1 x N.O.) CA5-01 (1 x N.C.)
	Side mounting	CAL5-11 (1 x N.O. + 1 x N.C.)
<b>Timers</b>	Electronic	TEF5-ON TEF5-OFF TE5S (for star-delta starters - direct timing - separate mounting)
	Mechanical	VM5-1
<b>Interlocking units</b>	Mechanical / Electrical	VE5-1   VE5-2
	Varistor (AC / DC)	RV5 (24...440 V)
<b>Surge suppressors</b>	RC Type (AC)	RC5-1 (24...440 V)   RC5-2 (24...440 V)





# A contactors and N contactor relays

## A 3-pole contactors

Overview	3/2
----------	-----

### 4 to 55 kW / 5 to 75 hp

A9 ... A16	AC operated	3/4
A26 ... A40	AC operated	3/5
A50 ... A75	AC operated	3/6
A95 ... A110	AC operated	3/7
Main accessories		3/8

### 75 to 160 kW / 100 to 250 hp

A145 ... A300	AC operated	3/11
Main accessories		3/12

Technical data	3/14
Terminal marking and positioning	3/27
Star-delta starting of three-phase asynchronous motors	3/28

## A 4-pole contactors

Overview	3/30
----------	------

### 25 to 125 A AC-1

A9 ... A16	AC operated	3/31
A26	AC operated	3/32
A45 ... A75	AC operated	3/33
Main accessories		3/34
Technical data		3/36
Terminal marking and positioning		3/44

## N contactor relays

N	AC operated	3/45
Main accessories		3/46
Technical data		3/48
Terminal marking and positioning		3/50

## Accessories for A contactors and N contactor relays

Auxiliary contact blocks	3/52
Electronic timers	3/55
Mechanical and electrical interlock units	3/58
Electronic timers for star-delta starters	3/60
Surge suppressors for contactor coils	3/62
Interface relays	3/64
Mechanical latching units	3/66
Function markers - Impulse contact blocks	3/68
Terminal shrouds, terminal enlargements, terminal extensions, connector terminals	3/69

Voltage code table	3/70
--------------------	------

# 3-pole contactors, for motor control and power switching

3



IEC (1)	AC-3 Rated operational power	$\theta \leq 55^\circ\text{C}$ , 400 V	kW	4	5.5	7.5	11	15	18.5
UL/CSA	3-phase motor rating	480 V	hp	5	7.5	10	20	25	30
AC Control supply		Type		A9	A12	A16	A26	A30	A40
IEC	AC-3 Rated operational current	$\theta \leq 55^\circ\text{C}$ , 400 V	A	9	12	17	26	32	37
	AC-1 Rated operational current	$\theta \leq 40^\circ\text{C}$ , 690 V	A	25	27	30	45	55	60
UL/CSA	General use rating	600 V	A	21	25	30	40	50	60
NEMA	NEMA Size			00	0	—	1	1P	—

(1) 1000 V IEC ratings available for A50 ... A300 contactors.

## Main accessories

Auxiliary contact blocks	Front mounting	CA5-10 (1 x N.O.) CA5-01 (1 x N.C.)	
	Side mounting	CAL5-11 (1 x N.O. + 1 x N.C.)	
Timers	Electronic	TEF5-ON TEF5-OFF TE5S (for star-delta starters - direct timing - separate mounting)	
		Interlocking units	Mechanical VM5-1
		Mechanical / Electrical VE5-1	
Surge suppressors	Varistor (AC/DC)	RV5 (24...440 V)	
	RC Type (AC)	RC5-1 (24...440 V)	

## Overload relays

Thermal relays	Class 10A (Class 10A or 20 for TA80DU) (Class 30 for TA450SU)	TA25DU-M (0.10...32 A)
		TA42DU-M (18...42 A)



## Manual motor starters

	Thermal / magnetic protection Class 10	MS116 (0.10...32 A) lcs up to 50 kA for class 10 A	MS450 (28...50 A) lcs up to 50 kA
	Magnetic only types	MS132 (0.10...32 A) lcs up to 100 kA	MS497 (22...100 A) lcs up to 100 kA
MO132 (0.16...32 A) lcs up to 100 kA		MO496 (32...100 A) lcs up to 100 kA	
		MO450 (40...50 A) lcs up to 50 kA	



22	30	37	45	55	75	90	110	140	160
40	60	60	60	75	100	125	150	200	250
<b>A50</b>	<b>A63</b>	<b>A75</b>	<b>A95</b>	<b>A110</b>	<b>A145</b>	<b>A185</b>	<b>A210</b>	<b>A260</b>	<b>A300</b>
50	65	75	96	110	145	185	210	260	305
100	115	125	145	160	250	275	350	400	500
80	90	105	125	150	230	250	300	350	400
2	—	3	—	—	4	—	—	5	—

		<b>CAL18-11</b> (1 x N.O. + 1 x N.C.)	
<b>VE5-2</b>		<b>VM300H</b> <b>VM300V</b>	
<b>RC5-2</b> (24...440 V)		<b>RC5-3</b> (250...440 V)	

<b>TA75DU-M</b> (18...80 A)	<b>TA80DU</b> (29...80 A) <b>TA110DU</b> (66...110 A)	<b>TA200DU</b> (66...200 A)	<b>TA450DU</b> (130...310 A) <b>TA450SU</b> (40...310 A)
-----------------------------	--	-----------------------------	---

**Short-circuit protection devices**

Tmax Circuit breaker and accessories

<b>MS495</b> (45...100 A) Ics up to 50 kA	<b>MO495</b> (63...100 A) Ics up to 50 kA
--	--



# A9 ... A16 3-pole contactors

## 4 to 7.5 kW

### AC operated



1SBC573 122F0301

3

A9-30-10

#### Description

A9 ... A16 contactors are mainly used for controlling 3-phase motors and power circuits up to 690 V AC or 220 V DC.

These contactors are of the block type design with:

- 3 main poles and 1 built-in auxiliary contact
- control circuit: AC operated
- add-on auxiliary contact blocks for front or side mounting and a wide range of accessories.

#### Ordering details

IEC Rated operational power 400 V AC-3 kW	UL/CSA 3-phase motor rating 480 V AC-1 A	General use rating 600 V AC hp	General use rating 600 V AC A	Rated control circuit voltage Uc (1)		Auxiliary contacts fitted 	Type	Order code	Weight kg
				V 50 Hz	V 60 Hz				
4	25	5	21	24	24	1 0	A9-30-10	1SBL141001R8110	0.340
						0 1	A9-30-01	1SBL141001R8101	0.340
				48	48	1 0	A9-30-10	1SBL141001R8310	0.340
						0 1	A9-30-01	1SBL141001R8301	0.340
				110	110...120	1 0	A9-30-10	1SBL141001R8410	0.340
						0 1	A9-30-01	1SBL141001R8401	0.340
				220...230	230...240	1 0	A9-30-10	1SBL141001R8010	0.340
						0 1	A9-30-01	1SBL141001R8001	0.340
				230...240	240...260	1 0	A9-30-10	1SBL141001R8810	0.340
						0 1	A9-30-01	1SBL141001R8801	0.340
				380...400	400...415	1 0	A9-30-10	1SBL141001R8510	0.340
						0 1	A9-30-01	1SBL141001R8501	0.340
				400...415	415...440	1 0	A9-30-10	1SBL141001R8610	0.340
						0 1	A9-30-01	1SBL141001R8601	0.340
5.5	27	7.5	25	24	24	1 0	A12-30-10	1SBL161001R8110	0.340
						0 1	A12-30-01	1SBL161001R8101	0.340
				48	48	1 0	A12-30-10	1SBL161001R8310	0.340
						0 1	A12-30-01	1SBL161001R8301	0.340
				110	110...120	1 0	A12-30-10	1SBL161001R8410	0.340
						0 1	A12-30-01	1SBL161001R8401	0.340
				220...230	230...240	1 0	A12-30-10	1SBL161001R8010	0.340
						0 1	A12-30-01	1SBL161001R8001	0.340
				230...240	240...260	1 0	A12-30-10	1SBL161001R8810	0.340
						0 1	A12-30-01	1SBL161001R8801	0.340
				380...400	400...415	1 0	A12-30-10	1SBL161001R8510	0.340
						0 1	A12-30-01	1SBL161001R8501	0.340
				400...415	415...440	1 0	A12-30-10	1SBL161001R8610	0.340
						0 1	A12-30-01	1SBL161001R8601	0.340
7.5	30	10	30	24	24	1 0	A16-30-10	1SBL181001R8110	0.340
						0 1	A16-30-01	1SBL181001R8101	0.340
				48	48	1 0	A16-30-10	1SBL181001R8310	0.340
						0 1	A16-30-01	1SBL181001R8301	0.340
				110	110...120	1 0	A16-30-10	1SBL181001R8410	0.340
						0 1	A16-30-01	1SBL181001R8401	0.340
				220...230	230...240	1 0	A16-30-10	1SBL181001R8010	0.340
						0 1	A16-30-01	1SBL181001R8001	0.340
				230...240	240...260	1 0	A16-30-10	1SBL181001R8810	0.340
						0 1	A16-30-01	1SBL181001R8801	0.340
				380...400	400...415	1 0	A16-30-10	1SBL181001R8510	0.340
						0 1	A16-30-01	1SBL181001R8501	0.340
				400...415	415...440	1 0	A16-30-10	1SBL181001R8610	0.340
						0 1	A16-30-01	1SBL181001R8601	0.340

(1) Other control voltages see voltage code table.

#### Main dimensions mm, inches

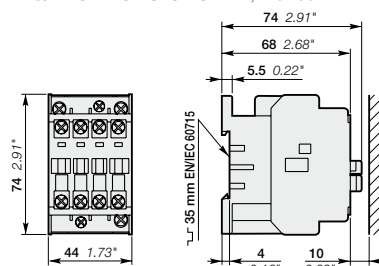

A9, A12, A16

1SBC10186550201

# A26 ... A40 3-pole contactors

## 11 to 18.5 kW

### AC operated



A26-30-10



A40-30-10

#### Description

A26 ... A40 contactors are mainly used for controlling 3-phase motors and power circuits up to 690 V AC or 220 V DC.

These contactors are of the block type design with:

- 3 main poles and 1 built-in auxiliary contact
- control circuit: AC operated
- add-on auxiliary contact blocks for front or side mounting and a wide range of accessories.

#### Ordering details

IEC		UL/CSA		Rated control circuit voltage		Auxiliary contacts fitted	Type	Order code	Weight
Rated operational power	current	3-phase motor rating	General use rating	Uc (1)					
400 V AC-3	AC-1	480 V	600 V AC	V 50 Hz	V 60 Hz			kg	
11 kW	45 A	20 hp	40 A	24	24	1 0	A26-30-10	1SBL241001R8110	0.600
						0 1	A26-30-01	1SBL241001R8101	0.600
				48	48	1 0	A26-30-10	1SBL241001R8310	0.600
						0 1	A26-30-01	1SBL241001R8301	0.600
				110	110...120	1 0	A26-30-10	1SBL241001R8410	0.600
						0 1	A26-30-01	1SBL241001R8401	0.600
				220...230	230...240	1 0	A26-30-10	1SBL241001R8010	0.600
						0 1	A26-30-01	1SBL241001R8001	0.600
				230...240	240...260	1 0	A26-30-10	1SBL241001R8810	0.600
						0 1	A26-30-01	1SBL241001R8801	0.600
				380...400	400...415	1 0	A26-30-10	1SBL241001R8510	0.600
						0 1	A26-30-01	1SBL241001R8501	0.600
				400...415	415...440	1 0	A26-30-10	1SBL241001R8610	0.600
						0 1	A26-30-01	1SBL241001R8601	0.600
15 kW	55 A	25 hp	50 A	24	24	1 0	A30-30-10	1SBL281001R8110	0.710
						0 1	A30-30-01	1SBL281001R8101	0.710
				48	48	1 0	A30-30-10	1SBL281001R8310	0.710
						0 1	A30-30-01	1SBL281001R8301	0.710
				110	110...120	1 0	A30-30-10	1SBL281001R8410	0.710
						0 1	A30-30-01	1SBL281001R8401	0.710
				220...230	230...240	1 0	A30-30-10	1SBL281001R8010	0.710
						0 1	A30-30-01	1SBL281001R8001	0.710
				230...240	240...260	1 0	A30-30-10	1SBL281001R8810	0.710
						0 1	A30-30-01	1SBL281001R8801	0.710
				380...400	400...415	1 0	A30-30-10	1SBL281001R8510	0.710
						0 1	A30-30-01	1SBL281001R8501	0.710
				400...415	415...440	1 0	A30-30-10	1SBL281001R8610	0.710
						0 1	A30-30-01	1SBL281001R8601	0.710
18.5 kW	60 A	30 hp	60 A	24	24	1 0	A40-30-10	1SBL321001R8110	0.710
						0 1	A40-30-01	1SBL321001R8101	0.710
				48	48	1 0	A40-30-10	1SBL321001R8310	0.710
						0 1	A40-30-01	1SBL321001R8301	0.710
				110	110...120	1 0	A40-30-10	1SBL321001R8410	0.710
						0 1	A40-30-01	1SBL321001R8401	0.710
				220...230	230...240	1 0	A40-30-10	1SBL321001R8010	0.710
						0 1	A40-30-01	1SBL321001R8001	0.710
				230...240	240...260	1 0	A40-30-10	1SBL321001R8810	0.710
						0 1	A40-30-01	1SBL321001R8801	0.710
				380...400	400...415	1 0	A40-30-10	1SBL321001R8510	0.710
						0 1	A40-30-01	1SBL321001R8501	0.710
				400...415	415...440	1 0	A40-30-10	1SBL321001R8610	0.710
						0 1	A40-30-01	1SBL321001R8601	0.710

(1) Other control voltages see voltage code table.

#### Main dimensions mm, inches

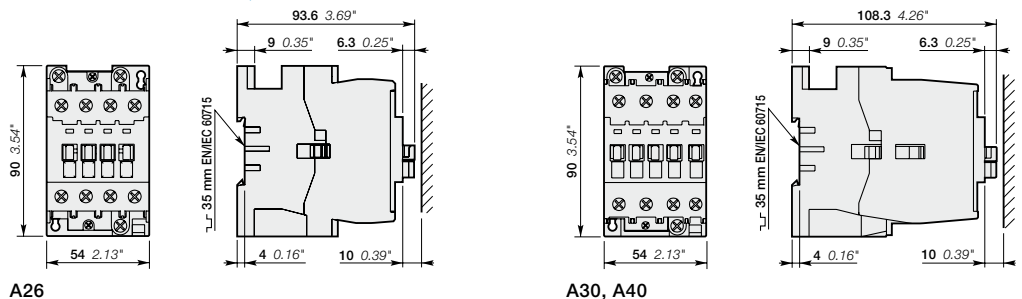

A26

A30, A40

1SBC101856S0201

# A50 ... A75 3-pole contactors

## 22 to 37 kW

### AC operated



1SBC10136450201

A50-30-11

3

#### Description

A50 ... A75 contactors are mainly used for controlling 3-phase motors and power circuits up to 690 V AC / 1000 V AC or 220 V DC.

These contactors are of the block type design with:

- 3 main poles
- control circuit: AC operated
- add-on auxiliary contact blocks for front or side mounting and a wide range of accessories.

#### Ordering details

IEC Rated operational power 400 V AC-3 kW	UL/CSA 3-phase motor rating 480 V AC-1 A	General use rating 600 V AC: hp	General use rating 600 V AC: A	Rated control circuit voltage Uc (1)		Auxiliary contacts fitted 	Type	Order code	Weight kg Pkg (1 pce)
				V 50 Hz	V 60 Hz				
22	100	40	80	24	24	1 1	A50-30-11	1SBL351001R8111	1.200
				48	48	1 1	A50-30-11	1SBL351001R8311	1.200
				110	110...220	1 1	A50-30-11	1SBL351001R8411	1.200
				220...230	230...240	1 1	A50-30-11	1SBL351001R8011	1.200
				230...240	240...260	1 1	A50-30-11	1SBL351001R8811	1.200
				380...400	400...415	1 1	A50-30-11	1SBL351001R8511	1.200
30	115	60	90	24	24	1 1	A63-30-11	1SBL371001R8111	1.200
				48	48	1 1	A63-30-11	1SBL371001R8311	1.200
				110	110...220	1 1	A63-30-11	1SBL371001R8411	1.200
				220...230	230...240	1 1	A63-30-11	1SBL371001R8011	1.200
				230...240	240...260	1 1	A63-30-11	1SBL371001R8811	1.200
				380...400	400...415	1 1	A63-30-11	1SBL371001R8511	1.200
37	125	60	105	24	24	1 1	A75-30-11	1SBL411001R8111	1.200
				48	48	1 1	A75-30-11	1SBL411001R8311	1.200
				110	110...220	1 1	A75-30-11	1SBL411001R8411	1.200
				220...230	230...240	1 1	A75-30-11	1SBL411001R8011	1.200
				230...240	240...260	1 1	A75-30-11	1SBL411001R8811	1.200
				380...400	400...415	1 1	A75-30-11	1SBL411001R8511	1.200
				400...415	415...440	1 1	A75-30-11	1SBL411001R8611	1.200

(1) Other control voltages see voltage code table.

#### Main dimensions mm, inches

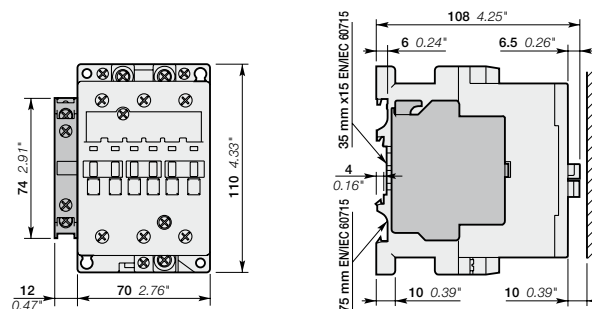

A50, A63, A75

1SBC10136450201

# A95 ... A110 3-pole contactors

## 45 to 55 kW

### AC operated



A95-30-11

1SBC573242F0301

#### Description

A95 ... A110 contactors are mainly used for controlling 3-phase motors and power circuits up to 690 / 1000 V AC or 220 V DC.

These contactors are of the block type design with:

- 3 main poles
- control circuit: AC operated
- add-on auxiliary contact blocks for front or side mounting and a wide range of accessories.

#### Ordering details

IEC		UL / CSA		Rated control circuit voltage U <sub>c</sub> (1)		Auxiliary contacts fitted	Type	Order code	Weight
Rated operational power	Rated operational current I <sub>n</sub> at θ ≤ 40 °C	3-phase motor rating	General use rating	V 50 Hz	V 60 Hz				
400 V AC-3	AC-1	480 V	600 V AC						kg
45 kW	145 A	60 hp	125 A	24	24	1 1	A95-30-11	1SFL431001R8111	2.040
				48	48	1 1	A95-30-11	1SFL431001R8311	2.040
				110	110...120	1 1	A95-30-11	1SFL431001R8411	2.040
				220...230	230...240	1 1	A95-30-11	1SFL431001R8011	2.040
				230...240	240...260	1 1	A95-30-11	1SFL431001R8811	2.040
				380...400	400...415	1 1	A95-30-11	1SFL431001R8511	2.040
				400...415	415...440	1 1	A95-30-11	1SFL431001R8611	2.040
55 kW	160 A	75 hp	140 A	24	24	1 1	A110-30-11	1SFL451001R8111	2.040
				48	48	1 1	A110-30-11	1SFL451001R8311	2.040
				110	110...120	1 1	A110-30-11	1SFL451001R8411	2.040
				220...230	230...240	1 1	A110-30-11	1SFL451001R8011	2.040
				230...240	240...260	1 1	A110-30-11	1SFL451001R8811	2.040
				380...400	400...415	1 1	A110-30-11	1SFL451001R8511	2.040
				400...415	415...440	1 1	A110-30-11	1SFL451001R8611	2.040

(1) Other control voltages see voltage code table.

#### Main dimensions mm, inches

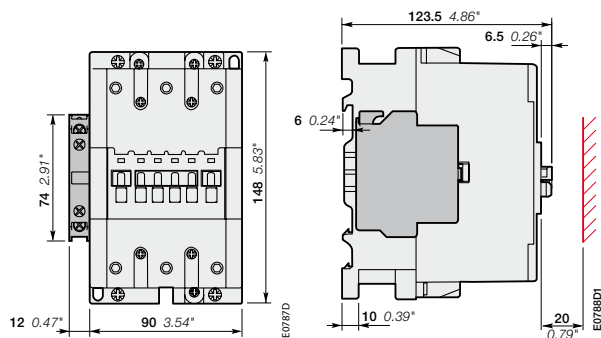

A95, A110

# A9 ... A110 3-pole contactors

## Main accessories

### Contactor and main accessories (other accessories available)

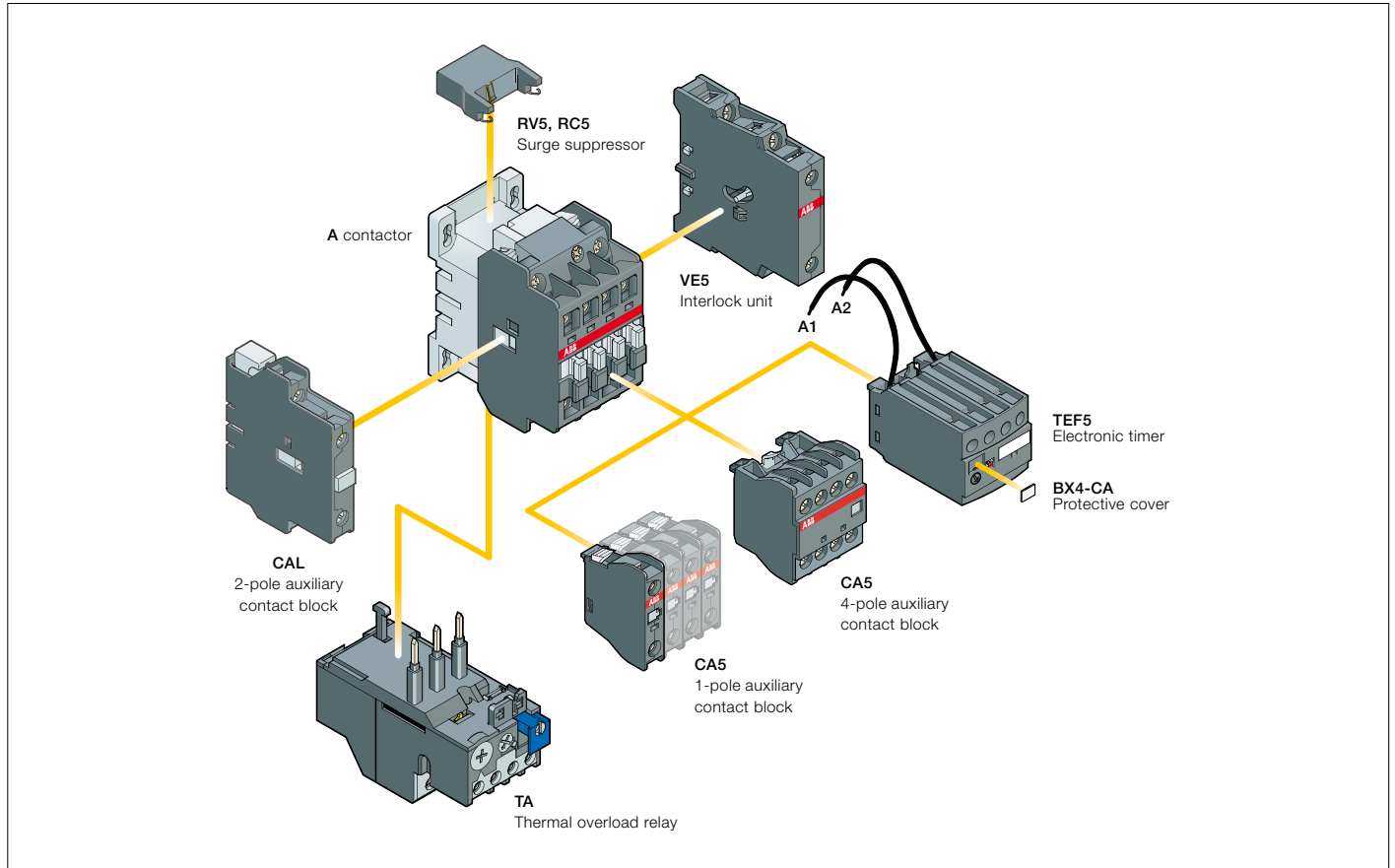

### Main accessory fitting details

Many configurations of accessories are possible depending on whether these are front-mounted or side-mounted.

Contactor types	Main poles	Built-in auxiliary contacts	Front-mounted accessories			Side-mounted accessories	
			Auxiliary contact blocks		Electronic timer	Auxiliary contact blocks	Interlock unit
			1-pole CA5	4-pole CA5	TEF5	2-pole CAL	VM5 or VE5
A9 ... A26	3 0	1 0	1 to 4 x CA5	or 1 x CA5 (4-pole)	or 1 x TEF5	+	1 to 2 x CAL5-11 or 1 x VM5-1 or VE5-1 +1 x CAL5-11
A30, A40	3 0	1 0	1 to 5 x CA5	or 1 x CA5 (4-pole) + 1 x 1-pole CA5	or 1 x TEF5 + 1 x CA5 (1-pole)	+	1 to 2 x CAL5-11 or 1 x VM5-1 or VE5-1 +1 x CAL5-11
A50 ... A75	3 0	1 1	1 to 6 x CA5	or 1 x CA5 (4-pole) + 2 x 1-pole CA5	or 1 x TEF5 + 2 x CA5 (1-pole)	+	1 x CAL5-11 or 1 x VE5-2
A95, A110	3 0	1 1	1 to 6 x CA5	or 1 x CA5 (4-pole) + 2 x 1-pole CA5	-	+	1 x CAL18-11 or 1 x VE5-2

(1) 2 N.C. CA5 auxiliary contacts maximum in mounting position 5.

### Overload relays fitting details (2)

Contactor types	Thermal overload relays
A9 ... A26	TA25DU-M (0.1...0.32 A)
A30, A40	TA25DU-M (0.1...0.32 A) or TA42DU-M (18...42 A)
A50 ... A75	TA75DU-M (18...80 A)
A95, A110	TA80DU (29...80 A) or TA110DU (65...110 A)

The addition of a thermal overload relay on the contactor does not prevent fitting of many other accessories as shown above.

(2) Direct mounting - No kit required.



# A9 ... A110 3-pole contactors

## Main accessories



CA5-10



CAL5-11



VE5-1

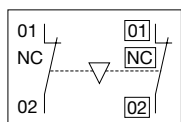

VE5-1, VE5-2  
Terminal marking and positioning



TEF5-OFF



RV5/50

### Ordering details (1)

For contactors	Auxiliary contacts	Type	Order code	Pkg qty	Weight (1 pce)
					kg

#### Front-mounted instantaneous auxiliary contact blocks

A9 ... A110	1 -	CA5-10	1SBN010010R1010	10	0.014
	- 1	CA5-01	1SBN010010R1001	10	0.014
A9-30-10 ... A40-30-10	2 2	CA5-22M	1SBN010040R1122	2	0.060
A9-30-01 ... A40-30-01	2 2	CA5-22U	1SBN010040R1322	2	0.060
A50 ... A110	2 2	CA5-22E	1SBN010040R1022	2	0.060

#### Side-mounted instantaneous auxiliary contact block

A9 ... A75	1 1	CAL5-11	1SBN010020R1011	2	0.050
A95, A110	1 1	CAL18-11	1SFN010720R1011	2	0.050

#### Interlock units

A9 ... A40	Mechanical	- -	VM5-1	1SBN030100R1000	1	0.066
	Mechanical and electrical	- 2	VE5-1	1SBN030110R1000	1	0.076
A50 ... A110	Mechanical and electrical	- 2	VE5-2	1SBN030210R1000	1	0.146

For contactors	Time delay range selected by switch	Delay type	Auxiliary contacts	Type	Order code	Pkg qty	Weight (1 pce)
							kg

#### Electronic timers

A9 ... A75	0.1...1 s	ON-delay	1 1	TEF5-ON	1SBN020312R1000	1	0.065
	1...10 s	OFF-delay	1 1	TEF5-OFF	1SBN020314R1000	1	0.065
	10...100 s						

Note: Rated control circuit voltage  $U_c$  24...240 V 50/60 Hz or DC.

For contactors	Rated control circuit voltage $U_c$		Type	Order code	Pkg qty	Weight (1 pce)
	V	AC DC				

#### Surge suppressors

A9 ... A110	24...50	● ●	RV5/50	1SBN050010R1000	2	0.015
	50...133	● ●	RV5/133	1SBN050010R1001	2	0.015
	110...250	● ●	RV5/250	1SBN050010R1002	2	0.015
	250...440	● ●	RV5/440	1SBN050010R1003	2	0.015
A9 ... A40	24...50	● -	RC5-1/50	1SBN050100R1000	2	0.012
	50...133	● -	RC5-1/133	1SBN050100R1001	2	0.012
	110...250	● -	RC5-1/250	1SBN050100R1002	2	0.012
	250...440	● -	RC5-1/440	1SBN050100R1003	2	0.012
A50 ... A110	24...50	● -	RC5-2/50	1SBN050200R1000	2	0.015
	50...133	● -	RC5-2/133	1SBN050200R1001	2	0.015
	110...250	● -	RC5-2/250	1SBN050200R1002	2	0.015
	250...440	● -	RC5-2/440	1SBN050200R1003	2	0.015

(1) See "Main accessory fitting details" table.

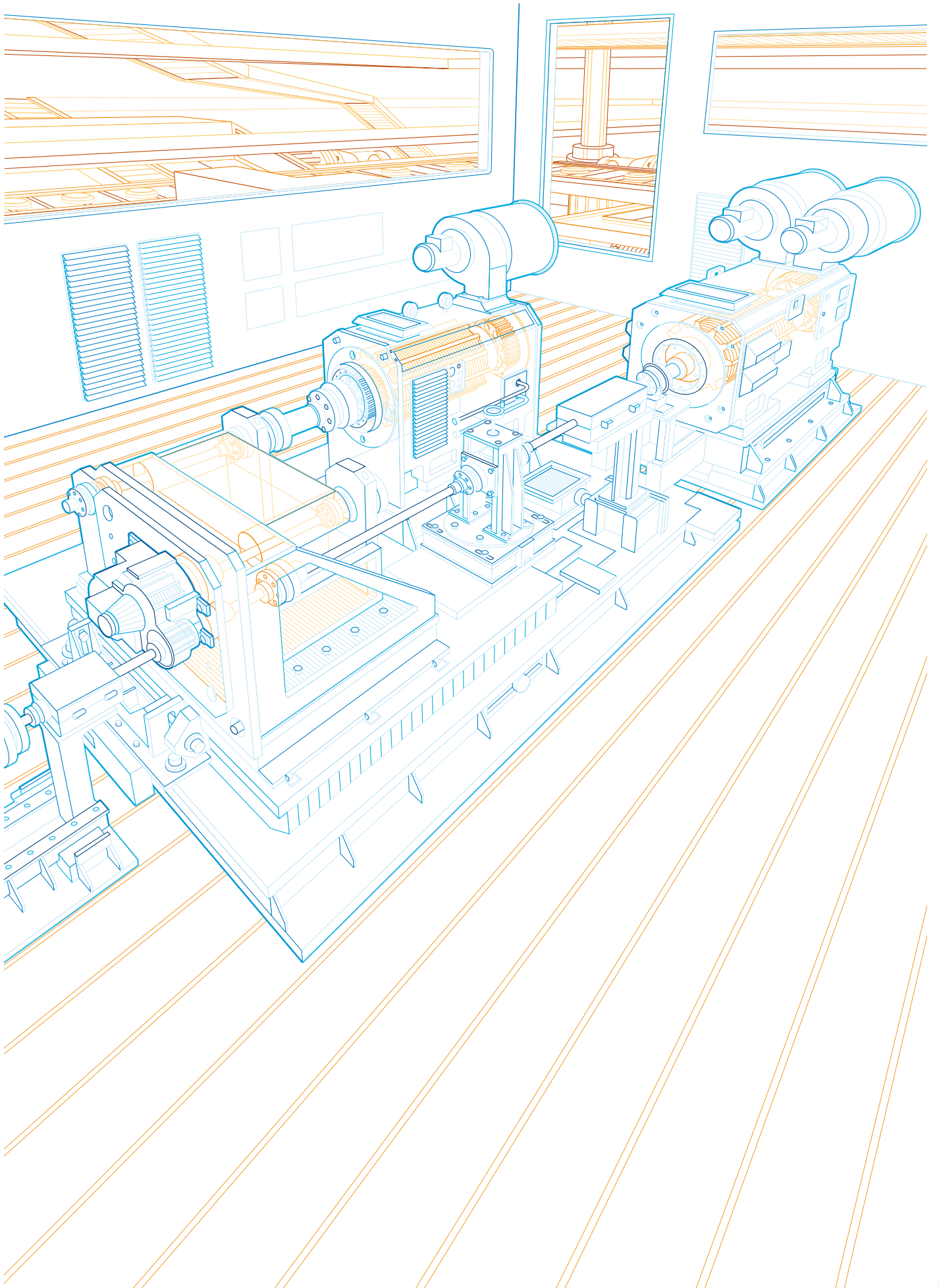

# A145 ... A300 3-pole contactors

## 75 to 160 kW

### AC operated



A185-30-11

1SFC101029F0201



A300-30-11

1SFC101030F0201

#### Description

A145 ... A300 contactors are mainly used for controlling 3-phase motors and power circuits up to 690 / 1000 V AC (2) or 220 V DC.

These contactors are of the block type design with:

- 3 main poles
- control circuit: AC operated
- add-on auxiliary contact blocks for side mounting and a wide range of accessories.

#### Ordering details

IEC		UL / CSA		Rated control circuit voltage		Auxiliary contacts fitted	Type	Order code	Weight
Rated operational power	Rated current $\theta \leq 40^\circ\text{C}$	3-phase motor rating	General use rating	Uc (1)					
400 V AC-3	690 V AC-1	480 V	600 V AC						
kW	A	hp	A	V 50 Hz	V 60 Hz			kg	
75	250	100	230	24	24	1 1	A145-30-11	1SFL471001R8111	3.500
				48	48	1 1	A145-30-11	1SFL471001R8311	3.500
				110	110...120	1 1	A145-30-11	1SFL471001R8411	3.500
				220...230	230...240	1 1	A145-30-11	1SFL471001R8011	3.500
				230...240	240...260	1 1	A145-30-11	1SFL471001R8811	3.500
				380...400	400...415	1 1	A145-30-11	1SFL471001R8511	3.500
				400...415	415...440	1 1	A145-30-11	1SFL471001R8611	3.500
90	275	125	250	24	24	1 1	A185-30-11	1SFL491001R8111	3.500
				48	48	1 1	A185-30-11	1SFL491001R8311	3.500
				110	110...120	1 1	A185-30-11	1SFL491001R8411	3.500
				220...230	230...240	1 1	A185-30-11	1SFL491001R8011	3.500
				230...240	240...260	1 1	A185-30-11	1SFL491001R8811	3.500
				380...400	400...415	1 1	A185-30-11	1SFL491001R8511	3.500
				400...415	415...440	1 1	A185-30-11	1SFL491001R8611	3.500
110	350	150	300	24	24	1 1	A210-30-11	1SFL511001R8111	6.100
				48	48	1 1	A210-30-11	1SFL511001R8311	6.100
				110	110...120	1 1	A210-30-11	1SFL511001R8411	6.100
				220...230	230...240	1 1	A210-30-11	1SFL511001R8011	6.100
				230...240	240...260	1 1	A210-30-11	1SFL511001R8811	6.100
				380...400	400...415	1 1	A210-30-11	1SFL511001R8511	6.100
				400...415	415...440	1 1	A210-30-11	1SFL511001R8611	6.100
140	400	200	350	24	24	1 1	A260-30-11	1SFL531001R8111	6.100
				48	48	1 1	A260-30-11	1SFL531001R8311	6.100
				110	110...120	1 1	A260-30-11	1SFL531001R8411	6.100
				220...230	230...240	1 1	A260-30-11	1SFL531001R8011	6.100
				230...240	240...260	1 1	A260-30-11	1SFL531001R8811	6.100
				380...400	400...415	1 1	A260-30-11	1SFL531001R8511	6.100
				400...415	415...440	1 1	A260-30-11	1SFL531001R8611	6.100
160	500	250	400	24	24	1 1	A300-30-11	1SFL551001R8111	6.100
				48	48	1 1	A300-30-11	1SFL551001R8311	6.100
				110	110...120	1 1	A300-30-11	1SFL551001R8411	6.100
				220...230	230...240	1 1	A300-30-11	1SFL551001R8011	6.100
				230...240	240...260	1 1	A300-30-11	1SFL551001R8811	6.100
				380...400	400...415	1 1	A300-30-11	1SFL551001R8511	6.100
				400...415	415...440	1 1	A300-30-11	1SFL551001R8611	6.100

(1) Other control voltages see voltage code table.

(2) 690 V AC for A210 ... A300, 1000 V AC for A145, A185.

#### Main dimensions mm, inches

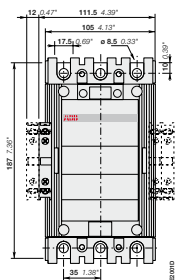

A145, A185

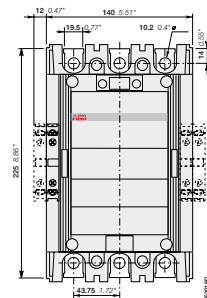
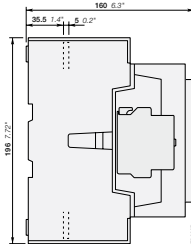

A210, A260, A300

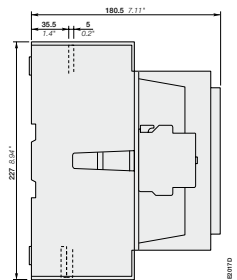

1SFC101147C0201

# A145 ... A300 3-pole contactors

## Main accessories

### Main accessories (other accessories available)

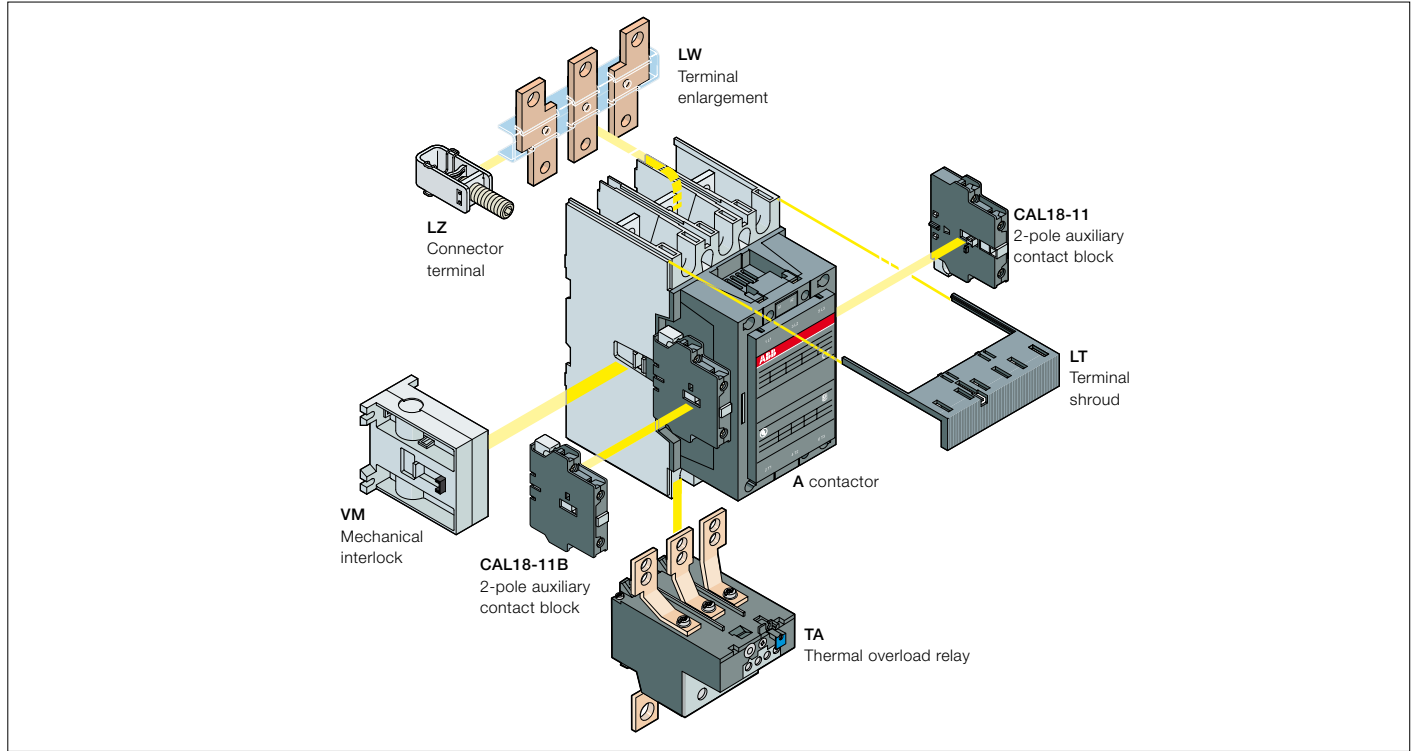

### Main accessory fitting details

Contactor types	Main poles	Available auxiliary contacts	Side-mounted accessories		Mechanical interlock units	Mounting and positioning
			Add-on auxiliary contact blocks			
			CAL18-11, CAL18-11B			Factory mounted auxiliary contacts Add-on CAL18-11 auxiliary contacts Add-on CAL18-11B auxiliary contacts

#### Contactors + auxiliary contact blocks

A145 ... A300	3	0	1	1	1 x CAL18-11	+	2 x CAL18-11B	-	
---------------	---	---	---	---	--------------	---	---------------	---	--

#### Contactors with mechanical interlocking + auxiliary contact blocks

A145 ... A185	3	0	1	1	2 x CAL18-11 (1)	+	3 x CAL18-11B (1)	+	VM...H (2)	
A210 ... A300	3	0	1	1	2 x CAL18-11 (1)	+	4 x CAL18-11B (1)	+	VM...H (2)	

(1) Total number of auxiliary contact blocks for the two contactors.

(2) Interlock type, according to the contactor ratings (see "Accessories").

### Overload relays fitting details

Contactor types	Thermal overload relays
A145, A185	TA200DU (66...200 A) (3)
A210, A300	TA450DU (130...310 A) (3) or TA450SU (40...310 A) (4)

The addition of a thermal or electronic overload relay on the contactor does not prevent fitting of many other accessories as shown in "Main accessory fitting details" table.

(3) Direct mounting - No kit required.

(4) Mounting kit required.

# A145 ... A300 3-pole contactors

## Main accessories



CAL18-11



VM300H



LT...AC



LT...AL



LT...AY



LW



LX



LZ



LZ



LZ

### Ordering details (1)

For contactors	Auxiliary contacts	Type	Order code	Pkg qty	Weight (1 pce)
					kg

### Side-mounted instantaneous auxiliary contact blocks

A145 ... A300	1 1	CAL18-11	1SFN010720R1011	2	0.050
	1 1	CAL18-11B	1SFN010720R3311	2	0.050

### Mechanical interlock unit for two horizontal mounted contactors

A145 ... A300	VM300H	1SFN034700R1000	1	0.150
---------------	--------	-----------------	---	-------

### Terminal shrouds

A145 ... A185 with connectors	LT185-AC	1SFN124701R1000	2	0.050
A145 ... A185 with lugs	LT185-AL	1SFN124703R1000	2	0.220
A145 ... A185 with short bar LY185 or between A145 and TA200DU or between A185 and TA200DU	LT185-AY	1SFN124704R1000	1	0.050
A210 ... A300 with connectors	LT300-AC	1SFN125101R1000	2	0.070
A210 ... A300 with lugs	LT300-AL	1SFN125103R1000	2	0.280
A210 ... A300 with short bar LY300	LT300-AY	1SFN125104R1000	1	0.075

For contactors	Dimensions		Type	Order code	Pkg qty	Weight (1 pce)
	hole Ø	bar				kg
	mm	mm				

### Terminal enlargements

A145, A185	10.5	20 x 5	LW185	1SFN074707R1000	1	0.250
A210 ... A300	10.5	25 x 5	LW300	1SFN075107R1000	1	0.450

### Terminal extension

A145, A185	8.5	20 x 5	LX185	1SFN074710R1000	1	0.250
A210 ... A300	10.5	20 x 5	LX300	1SFN075110R1000	1	0.350

Cables	For contactors	Cable cross section	Type	Order code	Pkg qty	Weight (1 pce)
		mm <sup>2</sup>				kg

### Connector terminals

Single Cu	A145, A185	6...185	-	1SDA023354R0001	3	0.200
	A210 ... A300	16...240	-	1SDA023368R0001	3	0.400
Single Al & Cu	A145, A185	35...95	-	1SDA023356R0001	3	0.100
	A145, A185	25...150	-	1SDA023357R0001	3	0.100
	A210 ... A300	120...240	-	1SDA023370R0001	3	0.200
Double Cu	A145, A185	2 x (50...120)	LZ185-2C/120	1SFN074709R1000	3	0.300
	A210 ... A300	2 x (95...120)	-	1SDA025766R0001	3	0.400

(1) For each contactor type, refer to "Main accessory fitting details" table.

For contactors	Rated control circuit voltage	Type	Order code	Pkg qty	Weight (1 pce)
	Uc				kg
	V AC				

A145 ... A300	250...440	RC5-3/440	1SFN050300R1003	2	0.028
---------------	-----------	-----------	-----------------	---	-------

# A9 ... A30 3-pole contactors

## Technical data

### Main pole - Utilization characteristics according to IEC

Contactors types	AC operated	A9	A12	A16	A26	A30
<b>Standards</b>		IEC 60947-1 / 60947-4-1 and EN 60947-1 / 60947-4-1				
<b>Rated operational voltage U<sub>e</sub> max.</b>		690 V				
<b>Rated frequency (without derating)</b>		50 / 60 Hz				
<b>Conventional free-air thermal current I<sub>th</sub></b>						
acc. to IEC 60947-4-1, open contactors, $\theta \leq 40^\circ\text{C}$		26 A	28 A	30 A	45 A	65 A
With conductor cross-sectional area		4 mm <sup>2</sup>	4 mm <sup>2</sup>	4 mm <sup>2</sup>	6 mm <sup>2</sup>	16 mm <sup>2</sup>
<b>AC-1 Utilization category</b>						
For air temperature close to contactor						
<b>I<sub>e</sub> / Rated operational current AC-1</b>						
U <sub>e</sub> max. $\leq 690\text{ V}$ , 50/60 Hz	$\theta \leq 40^\circ\text{C}$	25 A	27 A	30 A	45 A	55 A
	$\theta \leq 55^\circ\text{C}$	22 A	25 A	27 A	40 A	55 A
	$\theta \leq 70^\circ\text{C}$	18 A	20 A	23 A	32 A	39 A
With conductor cross-sectional area		2.5 mm <sup>2</sup>	4 mm <sup>2</sup>	4 mm <sup>2</sup>	6 mm <sup>2</sup>	10 mm <sup>2</sup>
<b>AC-3 Utilization category</b>						
For air temperature close to contactor $\theta \leq 55^\circ\text{C}$						
<b>I<sub>e</sub> / Max. rated operational current AC-3 (1)</b>						
	220-230-240 V	9 A	12 A	17 A	26 A	33 A
	380-400 V	9 A	12 A	17 A	26 A	32 A
	415 V	9 A	12 A	17 A	26 A	32 A
	440 V	9 A	12 A	16 A	26 A	32 A
	500 V	9 A	12 A	14 A	22 A	28 A
	690 V	7 A	9 A	10 A	17 A	21 A
<b>Rated operational power AC-3 (1)</b>						
	220-230-240 V	2.2 kW	3 kW	4 kW	6.5 kW	9 kW
	380-400 V	4 kW	5.5 kW	7.5 kW	11 kW	15 kW
	415 V	4 kW	5.5 kW	9 kW	11 kW	15 kW
	440 V	4 kW	5.5 kW	9 kW	15 kW	18.5 kW
	500 V	5.5 kW	7.5 kW	9 kW	15 kW	18.5 kW
	690 V	5.5 kW	7.5 kW	9 kW	15 kW	18.5 kW
<b>Rated making capacity AC-3</b>		10 x I <sub>e</sub> AC-3 acc. to IEC 60947-4-1				
<b>Rated breaking capacity AC-3</b>		8 x I <sub>e</sub> AC-3 acc. to IEC 60947-4-1				
<b>AC-8a Utilization category</b>						
(without thermal overload relay - U <sub>e</sub> 400 V 50/60 Hz - $\theta \leq 40^\circ\text{C}$ )						
<b>I<sub>e</sub> / Rated operational current AC-8a</b>		12 A	16 A	22 A	30 A	40 A
<b>Rated operational power AC-8a</b>		5.5 kW	7.5 kW	11 kW	15 kW	20 kW
<b>Short-circuit protection device for contactors</b>						
without thermal overload relay - Motor protection excluded (2)						
U <sub>e</sub> $\leq 500\text{ V AC}$ - gG type fuse		25 A	32 A	32 A	50 A	63 A
<b>Rated short-time withstand current I<sub>cw</sub></b>						
at 40 °C ambient temperature, in free air from a cold state	1 s	250 A	280 A	300 A	400 A	600 A
	10 s	100 A	120 A	140 A	210 A	400 A
	30 s	60 A	70 A	80 A	110 A	225 A
	1 min	50 A	55 A	60 A	90 A	150 A
	15 min	26 A	28 A	30 A	45 A	65 A
<b>Maximum breaking capacity</b>						
cos $\phi = 0.45$	at 440 V	250 A			420 A	820 A
	at 690 V	90 A			170 A	340 A
<b>Power dissipation per pole</b>						
	I <sub>e</sub> / AC-1	0.8 W	1 W	1.2 W	1.8 W	2.5 W
	I <sub>e</sub> / AC-3	0.1 W	0.2 W	0.35 W	0.6 W	0.9 W
<b>Max. electrical switching frequency</b>						
	AC-1	600 cycle/h				
	AC-3	1200 cycle/h				
	AC-2, AC-4	300 cycle/h				

(1) For the corresponding kW/A or hp/A values of 1500 r.p.m. 50 Hz or 1800 r.p.m. 60 Hz, 3-phase motors, see "Motor rated operational powers and currents".

(2) For the protection of motor starters against short circuits, see "Coordination with short-circuit protection devices".

# A40 ... A110 3-pole contactors

## Technical data

### Main pole - Utilization characteristics according to IEC

Contactor types	AC operated	A40	A50	A63	A75	A95	A110
<b>Standards</b>		IEC 60947-1 / 60947-4-1 and EN 60947-1 / 60947-4-1					
<b>Rated operational voltage U<sub>e</sub> max.</b>		690 V	1000 V				
<b>Rated frequency (without derating)</b>		50/60 Hz					
<b>Conventional free-air thermal current I<sub>th</sub></b> acc. to IEC 60947-4-1, open contactors, $\theta \leq 40\text{ °C}$		65 A	100 A	125 A	125 A	145 A	160 A
With conductor cross-sectional area		16 mm <sup>2</sup>	35 mm <sup>2</sup>	50 mm <sup>2</sup>	50 mm <sup>2</sup>	50 mm <sup>2</sup>	70 mm <sup>2</sup>
<b>AC-1 Utilization category</b> For air temperature close to contactor							
<b>I<sub>e</sub> / Rated operational current AC-1</b> U <sub>e</sub> max. $\leq 690\text{ V}$ , 50/60 Hz	$\theta \leq 40\text{ °C}$	60 A	100 A	115 A	125 A	145 A	160 A
	$\theta \leq 55\text{ °C}$	60 A	85 A	95 A	105 A	135 A	145 A
	$\theta \leq 70\text{ °C}$	42 A	70 A	80 A	85 A	115 A	130 A
With conductor cross-sectional area		16 mm <sup>2</sup>	35 mm <sup>2</sup>	50 mm <sup>2</sup>	50 mm <sup>2</sup>	50 mm <sup>2</sup>	70 mm <sup>2</sup>
<b>AC-3 Utilization category</b> For air temperature close to contactor $\theta \leq 55\text{ °C}$							
<b>I<sub>e</sub> / Max. rated operational current AC-3 (1)</b>							
	220-230-240 V	40 A	53 A	65 A	75 A	96 A	110 A
	380-400 V	37 A	50 A	65 A	75 A	96 A	110 A
	415 V	37 A	50 A	65 A	75 A	96 A	110 A
	440 V	37 A	45 A	65 A	70 A	93 A	100 A
	500 V	33 A	45 A	55 A	65 A	80 A	100 A
	690 V	25 A	35 A	43 A	46 A	65 A	82 A
	1000 V	–	23 A	25 A	28 A	30 A	30 A
<b>Rated operational power AC-3 (1)</b>							
	220-230-240 V	11 kW	15 kW	18.5 kW	22 kW	25 kW	30 kW
	380-400 V	18.5 kW	22 kW	30 kW	37 kW	45 kW	55 kW
	415 V	18.5 kW	25 kW	37 kW	40 kW	55 kW	59 kW
	440 V	22 kW	25 kW	37 kW	40 kW	55 kW	59 kW
	500 V	22 kW	30 kW	37 kW	45 kW	55 kW	59 kW
	690 V	22 kW	30 kW	37 kW	40 kW	55 kW	75 kW
	1000 V	–	30 kW	33 kW	37 kW	40 kW	40 kW
<b>Rated making capacity AC-3</b>		10 x I <sub>e</sub> AC-3 acc. to IEC 60947-4-1					
<b>Rated breaking capacity AC-3</b>		8 x I <sub>e</sub> AC-3 acc. to IEC 60947-4-1					
<b>AC-8a Utilization category</b> (without thermal overload relay - U <sub>e</sub> 400 V 50/60 Hz - $\theta \leq 40\text{ °C}$ )							
<b>I<sub>e</sub> / Rated operational current AC-8a</b>		50 A	63 A	85 A	95 A	120 A	140 A
<b>Rated operational power AC-8a</b>		22 kW	30 kW	45 kW	45 kW	55 kW	75 kW
<b>Short-circuit protection device for contactors</b> without thermal overload relay - Motor protection excluded (2) U <sub>e</sub> $\leq 500\text{ V AC}$ - gG type fuse		63 A	100 A	125 A	160 A	160 A	200 A
<b>Rated short-time withstand current I<sub>cw</sub></b> at 40 °C ambient temperature, in free air from a cold state	<b>1 s</b>	600 A	1000 A			1320 A	
	<b>10 s</b>	400 A	650 A			800 A	
	<b>30 s</b>	225 A	370 A			500 A	
	<b>1 min</b>	150 A	250 A			350 A	
	<b>15 min</b>	65 A	110 A	135 A	135 A	160 A	175 A
<b>Maximum breaking capacity</b> cos $\phi = 0.45$	<b>at 440 V</b>	820 A	1300 A			1160 A	
	<b>at 690 V</b>	340 A	630 A			800 A	
<b>Power dissipation per pole</b>	<b>I<sub>e</sub> / AC-1</b>	3 W	5 W	6.5 W	7 W	6.5 W	7.5 W
	<b>I<sub>e</sub> / AC-3</b>	1.3 W	1.3 W	1.5 W	2 W	2.7 W	3.6 W
<b>Max. electrical switching frequency</b>	<b>AC-1</b>	600 cycles/h				300 cycles/h	
	<b>AC-3</b>	1200 cycles/h	600 cycles/h		300 cycles/h		
	<b>AC-2, AC-4</b>	300 cycles/h	150 cycles/h				



3-phase motors



1500 r.p.m. 50 Hz  
1800 r.p.m. 60 Hz  
3-phase motors

(1) For the corresponding kW/A or hp/A values of 1500 r.p.m, 50 Hz or 1800 r.p.m, 60 Hz, 3-phase motors, see "Motor rated operational powers and currents".

(2) For the protection of motor starters against short circuits, see "Coordination with short-circuit protection devices".

# A145 ... A300 3-pole contactors

## Technical data

### Main pole - Utilization characteristics according to IEC

Contactor types	AC operated	A145	A185	A210	A260	A300
<b>Standards</b>		IEC 60947-1 / 60947-4-1 and EN 60947-1 / 60947-4-1				
<b>Rated operational voltage U<sub>e</sub> max.</b>		1000 V			690 V	
<b>Rated frequency (without derating)</b>		50/60 Hz				
<b>Conventional free-air thermal current I<sub>th</sub></b>						
acc. to IEC 60947-4-1, open contactors, $\theta \leq 40^\circ\text{C}$		250 A	275 A	350 A	400 A	500 A (4)
With conductor cross-sectional area (3)		120 mm <sup>2</sup>	150 mm <sup>2</sup>	185 mm <sup>2</sup>	240 mm <sup>2</sup>	300 mm <sup>2</sup> (4)
<b>AC-1 Utilization category</b>						
For air temperature close to contactor						
<b>I<sub>e</sub> / Rated operational current AC-1</b>	$\theta \leq 40^\circ\text{C}$	250 A	275 A	350 A	400 A	500 A (4)
U <sub>e</sub> max. $\leq 690\text{ V}$ , 50/60 Hz	$\theta \leq 55^\circ\text{C}$	230 A	250 A	300 A	350 A	400 A (4)
	$\theta \leq 70^\circ\text{C}$	180 A	180 A	240 A	290 A	325 A (4)
<b>I<sub>e</sub> / Rated operational current AC-1</b>	$\theta \leq 40^\circ\text{C}$	180 A	200 A	–	–	–
U <sub>e</sub> max. $\leq 1000\text{ V}$ , 50/60 Hz	$\theta \leq 55^\circ\text{C}$	180 A	200 A	–	–	–
	$\theta \leq 70^\circ\text{C}$	180 A	180 A	–	–	–
With conductor cross-sectional area		120 mm <sup>2</sup>	150 mm <sup>2</sup>	185 mm <sup>2</sup>	240 mm <sup>2</sup>	300 mm <sup>2</sup> (4)
<b>AC-3 Utilization category</b>						
For air temperature close to contactor $\theta \leq 55^\circ\text{C}$						
<b>I<sub>e</sub> / Max. rated operational current AC-3 (1)</b>						
	<b>220-230-240 V</b>	145 A	185 A	210 A	260 A	305 A
	<b>380-400 V</b>	145 A	185 A	210 A	260 A	305 A
	<b>415 V</b>	145 A	185 A	210 A	260 A	300 A
	<b>440 V</b>	145 A	185 A	210 A	240 A	280 A
	<b>500 V</b>	145 A	170 A	210 A	240 A	280 A
	<b>690 V</b>	120 A	170 A	210 A	220 A	280 A
	<b>1000 V</b>	80 A	95 A	–	–	–
<b>Rated operational power AC-3 (1)</b>						
	<b>220-230-240 V</b>	45 kW	55 kW	59 kW	80 kW	90 kW
	<b>380-400 V</b>	75 kW	90 kW	110 kW	140 kW	160 kW
	<b>415 V</b>	75 kW	90 kW	110 kW	140 kW	160 kW
	<b>440 V</b>	75 kW	90 kW	110 kW	140 kW	160 kW
	<b>500 V</b>	90 kW	110 kW	132 kW	180 kW	200 kW
	<b>690 V</b>	110 kW	132 kW	160 kW	200 kW	250 kW
	<b>1000 V</b>	110 kW	132 kW	–	–	–
<b>Rated making capacity AC-3</b>		10 x I <sub>e</sub> AC-3 acc. to IEC 60947-4-1				
<b>Rated breaking capacity AC-3</b>		8 x I <sub>e</sub> AC-3 acc. to IEC 60947-4-1				
<b>Short-circuit protection device for contactors</b>						
without thermal overload relay - Motor protection excluded (2)						
U <sub>e</sub> $\leq 500\text{ V AC}$ - gG type fuse		315 A	355 A	400 A	500 A	500 A
<b>Rated short-time withstand current I<sub>cw</sub></b>	<b>1 s</b>	1800 A	2000 A	2500 A	3500 A	3500 A
at 40 °C ambient temperature,	<b>10 s</b>	1200 A	1500 A	1700 A	2400 A	2400 A
in free air from a cold state	<b>30 s</b>	800 A	1000 A	1200 A	1500 A	1500 A
	<b>1 min</b>	600 A	800 A	1000 A	1100 A	1100 A
	<b>15 min</b>	280 A	320 A	400 A	500 A	500 A
<b>Maximum breaking capacity</b>						
cos $\phi = 0.45$	<b>at 440 V</b>	1500 A	2000 A	2300 A	2600 A	3000 A
(cos $\phi = 0.35$ for I <sub>e</sub> > 100 A)	<b>at 690 V</b>	1200 A	1600 A	2000 A	2400 A	2500 A
<b>Power dissipation per pole</b>	<b>I<sub>e</sub> / AC-1</b>	13 W	16 W	18 W	25 W	32 W
	<b>I<sub>e</sub> / AC-3</b>	5 W	8 W	9 W	14 W	18 W
<b>Max. electrical switching frequency</b>	<b>AC-1</b>	300 cycles/h			300 cycles/h	
	<b>AC-3</b>	300 cycles/h			300 cycles/h	
	<b>AC-2, AC-4</b>	150 cycles/h			150 cycles/h	



3-phase motors



1500 r.p.m. 50 Hz  
1800 r.p.m. 60 Hz  
3-phase motors

(1) For the corresponding kW/A or hp/A values of 1500 r.p.m, 50 Hz or 1800 r.p.m, 60 Hz, 3-phase motors, see "Motor rated operational powers and currents".

(2) For the protection of motor starters against short circuits, see "Coordination with short-circuit protection devices".

(3) Conductors with preparation.

(4) Use terminal extension / enlargement pieces (LX 300 / LW 300).



# A9 ... A30 3-pole contactors

## Technical data

### Main pole - Utilization characteristics according to UL / NEMA / CSA

Contactor types	AC operated	A9	A12	A16	A26	A30
Standards		UL 508, CSA C22.2 N°14				
Max. operational voltage		600 V				
NEMA size		00	0	-	1	1P
NEMA continuous amp rating	Thermal current	9 A	18 A	-	27 A	36 A
NEMA maximum horse power ratings 1-phase, 60 Hz	115 V AC	1/3 hp	1 hp	-	2 hp	3 hp
	230 V AC	1 hp	2 hp	-	3 hp	5 hp
NEMA maximum horse power ratings 3-phase, 60 Hz	200 V AC	1-1/2 hp	3 hp	-	7-1/2 hp	-
	230 V AC	1-1/2 hp	3 hp	-	7-1/2 hp	-
	460 V AC	1-1/2 hp	5 hp	-	10 hp	-
	575 V AC	2 hp	5 hp	-	10 hp	-
UL / CSA general use rating 600 V AC		21 A	25 A	30 A	40 A	50 A
With conductor cross-sectional area		AWG 10				
UL / CSA maximum 1-phase motor rating						
Full load current	120 V AC	9.8 A	13.8 A	16 A	28 A	34 A
	240 V AC	12 A	12 A	17 A	24 A	40 A
Horse power rating	120 V AC	1/2 hp	3/4 hp	1 hp	2 hp	3 hp
	240 V AC	2 hp	2 hp	3 hp	5 hp	7.5 hp
UL / CSA maximum 3-phase motor rating						
Full load current (1)	200-208 V AC	7.8 A	11 A	17.5 A	25.3 A	32.2 A
	220-240 V AC	6.8 A	9.6 A	15.2 A	28 A	28 A
	440-480 V AC	7.6 A	11 A	14 A	27 A	34 A
	550-600 V AC	9 A	11 A	17 A	27 A	32 A
Horse power rating (1)	200-208 V AC	2 hp	3 hp	5 hp	7.5 hp	10 hp
	220-240 V AC	2 hp	3 hp	5 hp	10 hp	10 hp
	440-480 V AC	5 hp	7.5 hp	10 hp	20 hp	25 hp
	550-600 V AC	7.5 hp	10 hp	15 hp	25 hp	30 hp
Short-circuit protection device for contactors without thermal overload relay - Motor protection excluded						
Fuse rating		35 A	35 A	60 A	90 A	150 A
Fuse type, 600 V		FRS-R				
Max. electrical switching frequency						
For general use		600 cycles/h				
For motor use		1200 cycles/h				

(1) For the corresponding kW/A or hp/A values of 1500 r.p.m, 50 Hz or 1800 r.p.m, 60 Hz, 3-phase motors, see "Motor rated operational powers and currents".

### General technical data

Contactor types	AC operated	A9	A12	A16	A26	A30
Rated insulation voltage $U_i$		1000 V				
acc. to IEC 60947-4-1		600 V				
acc. to UL / CSA		8 kV				
Rated impulse withstand voltage $U_{imp}$		8 kV				
Ambient air temperature close to contactor						
Operation	Fitted with thermal overload relay	-25...+55 °C				
	Without thermal overload relay	-40...+70 °C				
Storage		-60...+80 °C				
Climatic withstand		acc. to IEC 60068-2-30 and 60068-2-11 - UTE C 63-100 specification II				
Maximum operating altitude (without derating)		3000 m				
Mechanical durability						
Number of operating cycles		10 millions operating cycles				
Max. switching frequency		3600 cycles/h				
Shock withstand						
acc. to IEC 60068-2-27 and EN 60068-2-27						
Mounting position 1						
	Shock direction	1/2 sinusoidal shock for 11 ms: no change in contact position, closed or open position				
	A	20 g				
	B1	10 g closed position / 5 g open position				
	B2	15 g				
	C1	20 g				
	C2	20 g				

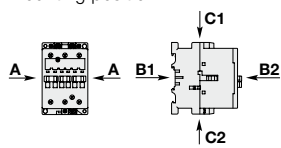

# A40 ... A110 3-pole contactors

## Technical data

### Main pole - Utilization characteristics according to UL / NEMA / CSA

Contactor types	AC operated	A40	A50	A63	A75	A95	A110
Standards		UL 508, CSA C22.2 N°14					
Max. operational voltage		600 V					
NEMA size		-	2	-	3	-	-
NEMA continuous amp rating	Thermal current	-	45 A	-	90 A	-	-
NEMA maximum horse power ratings							
1-phase, 60 Hz	115 V AC	-	3 hp	-	-	-	-
	230 V AC	-	7-1/2	-	-	-	-
NEMA maximum horse power ratings							
3-phase, 60 Hz	200 V AC	-	10 hp	-	25 hp	-	-
	230 V AC	-	15 hp	-	30 hp	-	-
	460 V AC	-	25 hp	-	50 hp	-	-
	575 V AC	-	25 hp	-	50 hp	-	-
UL / CSA general use rating							
600 V AC		60 A	80 A	90 A	105 A	125 A	150 A
With conductor cross-sectional area		AWG 6	AWG 4	AWG 3	AWG 2	AWG 1	AWG 1/0
UL / CSA maximum 1-phase motor rating							
Full load current	120 V AC	34 A	34 A	56 A	80 A	80 A	100 A
	240 V AC	40 A	40 A	50 A	68 A	88 A	110 A
Horse power rating	120 V AC	3 hp	3 hp	5 hp	7.5 hp	7.5 hp	10 hp
	240 V AC	7.5 hp	7.5 hp	10 hp	15 hp	20 hp	25 hp
UL / CSA maximum 3-phase motor rating							
Full load current (1)	200-208 V AC	32.2 A	48.3 A	62.1 A	78.2 A	92 A	92 A
	220-240 V AC	42 A	54 A	68 A	80 A	80 A	104 A
	440-480 V AC	40 A	52 A	77 A	77 A	77 A	96 A
	550-600 V AC	41 A	52 A	77 A	77 A	77 A	99 A
Horse power rating (1)	200-208 V AC	10 hp	15 hp	20 hp	25 hp	30 hp	30 hp
	220-240 V AC	15 hp	20 hp	25 hp	30 hp	30 hp	40 hp
	440-480 V AC	30 hp	40 hp	60 hp	60 hp	60 hp	75 hp
	550-600 V AC	40 hp	50 hp	75 hp	75 hp	75 hp	100 hp
Short-circuit protection device for contactors							
without thermal overload relay - Motor protection excluded							
Fuse rating		150 A	175 A	200 A	200 A	200 A	200 A
Fuse type, 600 V		FRS-R		J			
Max. electrical switching frequency							
For general use		600 cycles/h				300 cycles/h	
For motor use		1200 cycles/h	600 cycles/h		300 cycles/h		

(1) For the corresponding kW/A or hp/A values of 1500 r.p.m, 50 Hz or 1800 r.p.m, 60 Hz, 3-phase motors, see "Motor rated operational powers and currents".

### General technical data

Contactor types	AC operated	A40	A50	A63	A75	A95	A110
Rated insulation voltage Ui		1000 V					
acc. to IEC 60947-4-1		600 V					
acc. to UL / CSA		8 kV					
Rated impulse withstand voltage Uimp.		8 kV					
Ambient air temperature close to contactor							
Operation	Fitted with thermal overload relay	-25...+55 °C					
	Without thermal overload relay	-40...+70 °C					
Storage		-60...+80 °C				-40...+70 °C	
Climatic withstand		acc. to IEC 60068-2-30 and 60068-2-11 UTE C 63-100 specification II				acc. to IEC 60068-2-30	
Maximum operating altitude (without derating)		3000 m					
Mechanical durability							
Number of operating cycles		10 millions operating cycles					
Max. switching frequency		3600 cycles/h					
Shock withstand							
acc. to IEC 60068-2-27 and EN 60068-2-27							
Mounting position 1							
	Shock direction	1/2 sinusoidal shock for 11 ms: no change in contact position, closed or open position (2)					
	A	20 g					
	B1	10 g closed position / 5 g open position					
	B2	15 g					
	C1	20 g					
	C2	20 g					

(2) These values are not valid for rail mounting with contactors A95 ... A110.

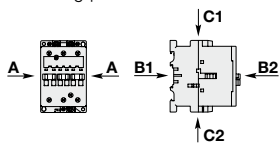

# A145 ... A300 3-pole contactors

## Technical data

### Main pole - Utilization characteristics according to UL / NEMA / CSA

Contactor types	AC operated	A145	A185	A210	A260	A300
Standards		UL 508, CSA C22.2 N°14				
Maximum operational voltage		600 V				
NEMA size		4	-	-	5	-
NEMA maximum horse power ratings						
1-phase, 60 Hz	115 V AC	-	-	-	-	-
	230 V AC	-	-	-	-	-
NEMA maximum horse power ratings						
3-phase, 60 Hz	200 V AC	40 hp			75 hp	
	230 V AC	50 hp			100 hp	
	460 V AC	100 hp			200 hp	
	575 V AC	200 hp			200 hp	
UL / CSA general use rating						
600 V AC		230 A	250 A	300 A	350 A	400 A
UL / CSA maximum 1-phase motor rating						
Full load current	240 V AC	-	-	-	-	-
Horse power rating	240 V AC	-	-	-	-	-
UL / CSA maximum 3-phase motor rating						
Full load current (1)	200-208 V AC	119.6 A	149.5 A	166.8 A	220.8 A	285.2 A
	220-240 V AC	130 A	145 A	192 A	248 A	248 A
	440-480 V AC	124 A	156 A	180 A	240 A	302 A
	550-600 V AC	125 A	144 A	192 A	242 A	289 A
Horse power rating (1)	200-208 V AC	40 hp	50 hp	60 hp	75 hp	100 hp
	220-240 V AC	50 hp	60 hp	75 hp	100 hp	100 hp
	440-480 V AC	100 hp	125 hp	150 hp	200 hp	250 hp
	550-600 V AC	125 hp	150 hp	200 hp	250 hp	300 hp
Short-circuit protection device for contactors						
without thermal overload relay - Motor protection excluded						
Fuse rating		300 A	400 A	800 A	800 A	800 A
Fuse type, 600 V		J/K5				
Maximum electrical switching frequency						
For general use		300 cycles/h				
For motor use		300 cycles/h				

(1) For the corresponding kW/A or hp/A values of 1500 r.p.m, 50 Hz or 1800 r.p.m, 60 Hz, 3-phase motors, see "Motor rated operational powers and currents".

### General technical data

Contactor types	AC operated	A145	A185	A210	A260	A300
Rated insulation voltage $U_i$						
acc. to IEC 60947-4-1		1000 V				
acc. to UL / CSA		600 V				
Rated impulse withstand voltage $U_{imp}$		8 kV				
Ambient air temperature close to contactor						
Operation Fitted with thermal overload relay		-25 to +55 °C				
Storage		-40 to +70 °C				
Climatic withstand		acc. to IEC 60068-2-30				
Maximum operating altitude (without derating)		3000 m				
Mechanical durability						
Number of operating cycles		5 millions operating cycles				
Max. switching frequency		3600 cycles/h				
Shock withstand						
acc. to IEC 60068-2-27 and EN 60068-2-27						
Mounting position 1						
Shock direction		1/2 sinusoidal shock for 30 ms: no change in contact position, closed or open position				
A		5 g				
B1		5 g				
B2		5 g				
C1		5 g				
C2		5 g				

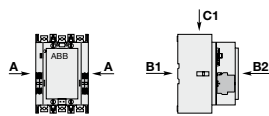

# A9 ... A30 3-pole contactors

## Technical data

### Magnet system characteristics

Contactor types		AC operated	A9	A12	A16	A26	A30
<b>Coil operating limits</b>		AC supply	at $\theta \leq 55^\circ\text{C}$ 0.85...1.1 x $U_c$				
acc. to IEC 60947-4-1			Please also refer to "Mounting characteristics and conditions for use"				
<b>AC control voltage 50/60 Hz</b>							
Rated control circuit voltage $U_c$		at 50 Hz	24...690 V				
		at 60 Hz	24...690 V				
Coil consumption	Average pull-in value	50 Hz	70 VA			120 VA	
		60 Hz	80 VA			140 VA	
		50/60 Hz (1)	74 VA / 70 VA			125 VA / 120 VA	
	Average holding value	50 Hz	8 VA / 2 W			12 VA / 3 W	
		60 Hz	8 VA / 2 W			12 VA / 3 W	
		50/60 Hz (1)	8 VA / 2 W			12 VA / 3 W	
<b>Drop-out voltage</b>			approx. 40...65 % of $U_c$				
<b>Operating time</b>							
Between coil energization and:	N.O. contact closing		10...26 ms			8...21 ms	
	N.C. contact opening		7...21 ms			6...18 ms	
Between coil de-energization and:	N.O. contact opening		4...11 ms			4...11 ms	
	N.C. contact closing		9...16 ms			7...14 ms	

(1) 50/60 Hz coils: see "Coil voltage code table".

### Mounting characteristics and conditions for use

Contactor types		AC operated	A9	A12	A16	A26	A30
<b>Mounting positions</b>							
			Max. N.O. or N.C. built-in and add-on N.O. or N.C. auxiliary contacts: see accessory fitting details for 3-pole contactor A9 ... A30				
<b>Control voltage / Ambient temperature</b>							
Mounting positions	1, 1±30°, 2, 3, 4, 5	at $\theta \leq 55^\circ\text{C}$	0.85...1.1 x $U_c$				
		at $\theta \leq 70^\circ\text{C}$	$U_c$				
	6	at $\theta \leq 55^\circ\text{C}$	0.95...1.1 x $U_c$				
		at $\theta \leq 70^\circ\text{C}$	Unauthorized				
<b>Mounting distances</b>			The contactors can be assembled side by side				
<b>Fixing</b>							
On rail according to IEC 60715, EN 60715			35 x 7.5 mm or 35 x 15 mm				
By screws (not supplied)			2 x M4 screws placed diagonally				

# A40 ... A110 3-pole contactors

## Technical data

### Magnet system characteristics

Contactor types	AC operated	A40	A50	A63	A75	A95	A110
<b>Coil operating limits</b>	AC supply	At $\theta \leq 55\text{ °C}$ 0.85...1.1 x $U_c$				at $\theta \leq 70\text{ °C}$ 0.85...1.1 x $U_c$	
acc. to IEC 60947-4-1		Please also refer to "Mounting characteristics and conditions for use"					
<b>AC control voltage 50/60 Hz</b>							
Rated control circuit voltage $U_c$		at 50 Hz 24...690 V					
		at 60 Hz 24...690 V					
Coil consumption	Average pull-in value	50 Hz	120 VA	180 VA		350 VA	
		60 Hz	140 VA	210 VA		450 VA	
	Average holding value	50/60 Hz (1)	125 VA / 120 VA	190 VA / 180 VA		410 VA / 365 VA	
		50 Hz	12 VA / 3 W	18 VA / 5.5 W		22 VA / 6.5 W	
		60 Hz	12 VA / 3 W	18 VA / 5.5 W		26 VA / 8 W	
		50/60 Hz (1)	12 VA / 3 W	18 VA / 5.5 W		27 VA / 7.5 W	
<b>Drop-out voltage</b>		Approx. 40...65 % of $U_c$					
<b>Operating time</b>							
Between coil energization and:	N.O. contact closing	8...21 ms	8...27 ms			10...25 ms	
	N.C. contact opening	6...18 ms	7...22 ms			7...22 ms	
Between coil de-energization and:	N.O. contact opening	4...11 ms	4...11 ms			7...15 ms	
	N.C. contact closing	7...14 ms	7...14 ms			10...18 ms	

(1) 50/60 Hz coils: see "Coil voltage code table".

### Mounting characteristics and conditions for use

Contactor types	AC operated	A40	A50	A63	A75	A95	A110
<b>Mounting positions</b>							
		Max. built-in and add-on N.O. or N.C. auxiliary contacts: see accessory fitting details for 3-pole contactor A40 ... A110					
<b>Control voltage / Ambient temperature</b>							
Mounting positions	1, 1±30°, 2, 3, 4, 5	at $\theta \leq 55\text{ °C}$	0.85...1.1 x $U_c$			0.85...1.1 x $U_c$	
		at $\theta \leq 70\text{ °C}$	$U_c$			0.85...1.1 x $U_c$	
	6	at $\theta \leq 55\text{ °C}$	0.95...1.1 x $U_c$			Unauthorized	
		at $\theta \leq 70\text{ °C}$	Unauthorized			Unauthorized	
<b>Mounting distances</b>		The contactors can be assembled side by side					
<b>Fixing</b>							
On rail according to IEC 60715, EN 60715		35 x 7.5 mm or 35 x 15 mm	35 x 15 mm or 75 x 25 mm				-
By screws (not supplied)		2 x M4 screws placed diagonally	2 x M6 screws placed diagonally			2 x M6 screws placed diagonally	

# A145 ... A300 3-pole contactors

## Technical data

### Magnet system characteristics

Contactor types		AC operated	A145	A185	A210	A260	A300	
Coil operating limits		AC supply	At $\theta \leq 70^\circ\text{C}$ 0.85...1.1 x $U_c$					
acc. to IEC 60947-4-1			Please also refer to "Mounting characteristics and conditions for use"					
AC control voltage	Rated control circuit voltage $U_c$	at 50 Hz	24...690 V					
		at 60 Hz	24...690 V					
Coil consumption	Average pull-in value	50 Hz	550 VA		1350 VA			
		60 Hz	600 VA		1550 VA			
		50/60 Hz (1)	700 VA / 650 VA		1700 VA / 1550 VA			
		Average holding value	50 Hz	35 VA / 11 W		60 VA / 16 W		
			60 Hz	40 VA / 12 W		65 VA / 19 W		
			50/60 Hz (1)	44 VA / 13 W		80 VA / 21 W		
Drop-out voltage			Approx. 40...65 % of $U_c$ min.					
Operating time								
Between coil energization and:		N.O. contact closing	13...27 ms		17...35 ms			
		N.C. contact opening	8...22 ms		12...30 ms			
Between coil de-energization and:		N.O. contact opening	5...10 ms		7...13 ms			
		N.C. contact closing	9...13 ms		10...16 ms			

(1) 50/60 Hz coils: see "Voltage code table".











### Mounting characteristics and conditions for use

Contactor types		AC operated	A145	A185	A210	A260	A300
Mounting positions							
Control voltage / Ambient temperature			Max. add-on N.O. or N.C. auxiliary contacts: see accessory fitting details for 3-pole contactor A145 ... A300				
Mounting positions	1, $1 \pm 30^\circ$ , 2, 3, 4, 5	at $\theta \leq 70^\circ\text{C}$	0.85 x $U_c$ ...1.1 x $U_c$				
	6		Unauthorized				
Mounting distances			The contactors can be assembled side by side				
Fixing	On rail according to IEC 60715, EN 60715		-				
	By screws (not supplied)		4 x M5				

# A9 ... A30 3-pole contactors

## Technical data

### Connecting characteristics













Contactor types	AC operated	A9	A12	A16	A26	A30
<b>Main terminals</b>		 Screw terminals with cable clamp				 Screw terminals with double connector 2 x (5.6 x 6.5 mm)
<b>Connection capacity</b> (min. ... max.)						
<b>Main conductors</b> (poles)						
 Rigid Solid ( $\leq 4 \text{ mm}^2$ )	} 1 x	1...4 mm <sup>2</sup>			1.5...6 mm <sup>2</sup>	2.5...16 mm <sup>2</sup>
 Stranded ( $\geq 6 \text{ mm}^2$ )		2 x	1...4 mm <sup>2</sup>			1.5...6 mm <sup>2</sup>
 Flexible with ferrule	1 x	0.75...2.5 mm <sup>2</sup>			0.75...4 mm <sup>2</sup>	2.5...10 mm <sup>2</sup>
 Flexible with ferrule	2 x	0.75...2.5 mm <sup>2</sup>			0.75...4 mm <sup>2</sup>	2.5...10 mm <sup>2</sup>
 Bars or lugs	L <	7.7 mm			10 mm	-
	I <	3.7 mm			4.2 mm	-
Connection capacity acc. to UL / CSA	1 or 2 x	AWG 18...10			AWG 12...8	AWG 8...4
Tightening torque	Recommended	1 Nm / 9 lb.in			1.7 Nm / 15 lb.in	2.3 Nm / 20 lb.in
	Max.	1.2 Nm			2.20 Nm	2.60 Nm
<b>Auxiliary conductors</b> (built-in auxiliary terminals + coil terminals)						
 Rigid solid	1 x	1...4 mm <sup>2</sup>				
	2 x	1...4 mm <sup>2</sup>				
 Flexible with ferrule	1 x	0.75...2.5 mm <sup>2</sup>				
	2 x	0.75...2.5 mm <sup>2</sup>				
 Lugs	L <	7.7 mm			(1)	8 mm
	I <	3.7 mm			(1)	3.7 mm
Connection capacity acc. to UL / CSA	1 or 2 x	AWG 18...14				
Tightening torque	Coil terminals					
	Recommended	1 Nm / 9 lb.in				
	Max.	1.20 Nm				
Built-in auxiliary terminals	Recommended	1 Nm / 9 lb.in			1.7 Nm / 15 lb.in	1 Nm / 9 lb.in
	Max.	1.20 Nm			2.20 Nm	1.20 Nm
<b>Degree of protection</b> acc. to IEC 60947-1 / EN 60947-1 and IEC 60529 / EN 60529						
Main terminals		IP20				
Coil terminals		IP20				
Built-in auxiliary terminals		IP20				
<b>Screw terminals</b>		Delivered in open position, screws of unused terminals must be tightened				
Main terminals		M3.5			M4	M5
	<b>Screwdriver type</b>	Flat Ø 5.5 / Pozidriv 2				Flat Ø 6.5 / Pozidriv 2
Coil terminals		M3.5				
	<b>Screwdriver type</b>	Flat Ø 5.5 / Pozidriv 2				
Built-in auxiliary terminals		M3.5			M4	M3.5
	<b>Screwdriver type</b>	Flat Ø 5.5 / Pozidriv 2				

(1) L ≤ 8 and I > 3.7 for coil terminals - L ≤ 10 and I > 4.2 for built-in auxiliary terminals.

# A40 ... A110 3-pole contactors

## Technical data

### Connecting characteristics

Contactor types	AC operated	A40	A50	A63	A75	A95	A110	
<b>Main terminals</b>		 Screw terminals with double connector 2 x (5.6 x 6.5 mm)	 Screw terminals with single connector (13 x 10 mm)			 Screw terminals with single connector (14 x 14 mm)		
<b>Connection capacity</b> (min. ... max.)								
<b>Main conductors</b> (poles)								
 Rigid	Solid ( $\leq 4 \text{ mm}^2$ )	} <b>1 x</b> 2.5...16 mm <sup>2</sup>	} 6...50 mm <sup>2</sup>			} 10...95 mm <sup>2</sup>		
 Stranded ( $\geq 6 \text{ mm}^2$ )								2 x 2.5...16 mm <sup>2</sup>
 Flexible with ferrule		<b>1 x</b> 2.5...10 mm <sup>2</sup>	6...35 mm <sup>2</sup>			10...70 mm <sup>2</sup> (1)		
 Flexible without ferrule		<b>2 x</b> 2.5...10 mm <sup>2</sup>	6...16 mm <sup>2</sup>			6...35 mm <sup>2</sup> (1)		
 Bars or lugs		<b>L &lt;</b> -	-			30 mm (2)		
		<b>l &lt;</b> -	-			6 mm		
Connection capacity acc. to UL / CSA	<b>1 or 2 x</b>	AWG 8...4	AWG 8...1			AWG 6...2/0		
Tightening torque	Recommended	2.30 Nm / 20 lb.in	4.00 Nm / 35 lb.in			8 Nm / 71 lb.in		
	Max.	2.60 Nm	4.50 Nm			9 Nm		
<b>Auxiliary conductors</b>								
(built-in auxiliary terminals + coil terminals)								
 Rigid solid		<b>1 x</b> 1...4 mm <sup>2</sup>				0.75...2.5 mm <sup>2</sup>		
		<b>2 x</b> 1...4 mm <sup>2</sup>				0.75...2.5 mm <sup>2</sup>		
 Flexible with ferrule		<b>1 x</b> 0.75...2.5 mm <sup>2</sup>	1...2.5 mm <sup>2</sup>			0.75...2.5 mm <sup>2</sup>		
 Flexible without ferrule		<b>2 x</b> 0.75...2.5 mm <sup>2</sup>						
 Lugs		<b>L &lt;</b> 8 mm						
		<b>l &lt;</b> 3.7 mm						
Connection capacity acc. to UL / CSA	<b>1 or 2 x</b>	AWG 18...14						
Tightening torque								
Coil terminals	Recommended	1.00 Nm / 9 lb.in						
	Max.	1.20 Nm						
Built-in auxiliary terminals	Recommended	1.00 Nm / 9 lb.in	-			-		
	Max.	1.20 Nm	-			-		
<b>Degree of protection</b>								
acc. to IEC 60947-1 / EN 60947-1 and IEC 60529 / EN 60529								
Main terminals		IP20	IP10					
Coil terminals		IP20						
Built-in auxiliary terminals		IP20	-			-		
<b>Screw terminals</b>								
Main terminals		Delivered in open position, screws of unused terminals must be tightened						
		M5	M6			M8		
	<b>Screwdriver type</b>	Flat Ø 6.5 / Pozidriv 2				Hexagon socket (s = 4 mm)		
Coil terminals		M3.5						
	<b>Screwdriver type</b>	Flat Ø 5.5 / Pozidriv 2						
Built-in auxiliary terminals		M3.5	-					
	<b>Screwdriver type</b>	Flat Ø 5.5 / Pozidriv 2	-					

(1) A95 / A110: use flexible without ferrule.







(2) With LW110 enlargement piece, see "Accessories".

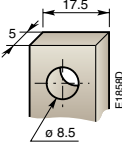
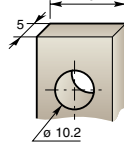

# A145 ... A300 3-pole contactors

## Technical data

### Connecting characteristics

Contactor types	AC operated	A145	A185	A210	A260	A300
<b>Main terminals</b> Flat type						
<b>Connection capacity (min. ... max.)</b>						
<b>Main conductors (poles)</b>						
 Rigid with connector	Single for Cu cable	6...185 mm <sup>2</sup>		16...240 mm <sup>2</sup>		
	Single for Al/Cu cable	25...150 mm <sup>2</sup>		120...240 mm <sup>2</sup>		
	Double for Al/Cu cable	–		2 x 95...120 mm <sup>2</sup>		
 Bars or lugs	<b>L</b> ≤	24 mm		32 mm		
	<b>Ø</b> >	8 mm		10 mm		
Connection capacity acc. to UL / CSA	<b>1 or 2 x</b>	6 - 250 MCM		4 - 500 MCM (1)		
Tightening torque	Recommended	18 Nm / 160 lb.in		28 Nm / 247 lb.in		
	Max.	20 Nm		30 Nm		
<b>Auxiliary conductors</b> (coil terminals)						
 Rigid solid	<b>1 x</b>	1...4 mm <sup>2</sup>				
	<b>2 x</b>	1...4 mm <sup>2</sup>				
 Flexible with ferrule	<b>1 x</b>	0.75...2.5 mm <sup>2</sup>				
	<b>2 x</b>	0.75...2.5 mm <sup>2</sup>				
 Lugs	<b>L</b> ≤	8 mm				
	<b>l</b> >	3.7 mm				
Connection capacity acc. to UL / CSA	<b>1 or 2 x</b>	AWG 18...14				
Tightening torque	Recommended	1.00 Nm / 9 lb.in				
	Max.	1.20 Nm				
<b>Degree of protection</b> acc. to IEC 60947-1 / EN 60947-1 and IEC 60529 / EN 60529						
Main terminals		IP00				
Coil terminals		IP20				
<b>Screw terminals</b>						
Main terminals		M8		M10		
		Screws and bolts				
Coil terminals (delivered in open position)		M3.5				
	<b>Screwdriver type</b>	Flat Ø 5.5 mm / Pozidriv 2				

(1) With LW110 enlargement piece: see "Accessories".

# A9 ... A40 3-pole contactors

## Technical data

### Built-in auxiliary contacts according to IEC - Other auxiliary contacts see "Accessories"

Contactor types	AC operated	A9	A12	A16	A26	A30	A40
Rated operational voltage U <sub>e</sub> max.		690 V					
Rated frequency (without derating)		50/60 Hz					
Conventional free air thermal current I <sub>th</sub> - θ ≤ 40 °C		16 A					
le / Rated operational current AC-15 acc. to IEC 60947-5-1		10 x I <sub>e</sub> AC-15 acc. to IEC 60947-5-1					
	24-127 V 50/60 Hz	6 A					
	220-240 V 50/60 Hz	4 A					
	380-440 V 50/60 Hz	3 A					
	500 V 50/60 Hz	2 A					
	690 V 50/60 Hz	2 A					
Making capacity AC-15		10 x I <sub>e</sub> AC-15 acc. to IEC 60947-5-1					
Breaking capacity AC-15		10 x I <sub>e</sub> AC-15 acc. to IEC 60947-5-1					
le / Rated operational current DC-13 acc. to IEC 60947-5-1		10 x I <sub>e</sub> DC-13 acc. to IEC 60947-5-1					
	24 V DC	6 A / 144 W					
	48 V DC	2.8 A / 134 W					
	72 V DC	2 A / 144 W					
	110 V DC	1.1 A / 121 W					
	125 V DC	1.1 A / 138 W					
	220 V DC	0.55 A / 121 W					
	250 V DC	0.55 A / 138 W					
Short-circuit protection device gG type fuse		10 A					
Rated short-time withstand current I <sub>cw</sub>	for 1.0 s	100 A					
	for 0.1 s	140 A					
Minimum switching capacity with failure rate acc. to IEC 60947-5-4		17 V / 5 mA ≤ 10 <sup>-7</sup> for AL40 and TAL40 contactors					
Non-overlapping time between N.O. and N.C. contacts		≥ 2 ms					
Power dissipation per pole at 6 A		0.1 W					
Max. electrical switching frequency	AC-15	1200 cycles/h					
	DC-13	900 cycles/h					
Mechanically linked contacts acc. to annex L of IEC 60947-5-1		Built-in N.O. or N.C. auxiliary contacts and additional N.O. or N.C. auxiliary contacts of 4-pole CA5 are mechanically linked contacts.					
Mirror contacts acc. to annex F of IEC 60947-4-1		Built-in N.C. auxiliary contacts or additional N.C. auxiliary contacts (CA5, CAL5-11) are mirror contacts.					

### Built-in auxiliary contacts according to UL / CSA

Contactor types	AC operated	A9	A12	A16	A26	A30	A40
Max. operational voltage		600 V AC, 600 V DC					
Pilot duty		A600, P300					
AC thermal rated current		10 A					
AC maximum volt-ampere making		7200 VA					
AC maximum volt-ampere breaking		720 VA					
DC thermal rated current		5 A					
DC maximum volt-ampere making-breaking		138 VA					

# A9 ... A300 3-pole contactors

## Terminal marking and positioning

### A9 ... A110 contactors - AC operated

Standard devices without addition of auxiliary contacts

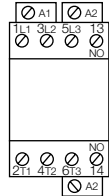

A9 ... A40-30-10

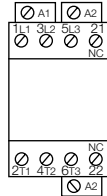

A9 ... A40-30-01

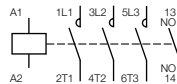

A9 ... A40-30-10

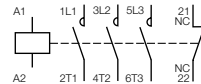

A9 ... A40-30-01

Standard devices with factory mounted auxiliary contacts

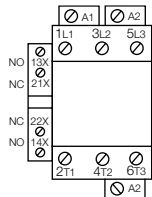

A50 ... A110-30-11

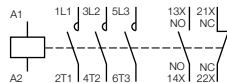

A50 ... A110-30-11

Other possible contact combinations with auxiliary contacts added by the user

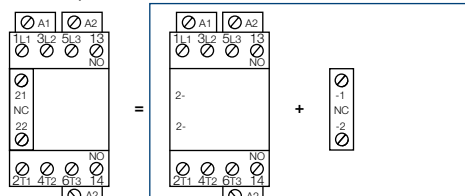

Combination 11 = A9 ... A40-30-10 + CA5-01

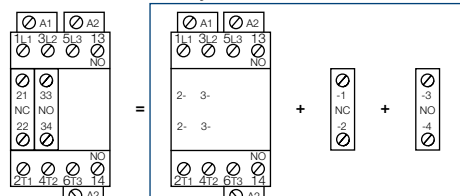

Combination 21 = A9 ... A40-30-10 + CA5-01 + CA5-10

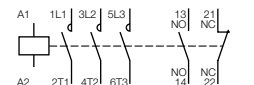

Combination 11



Combination 21

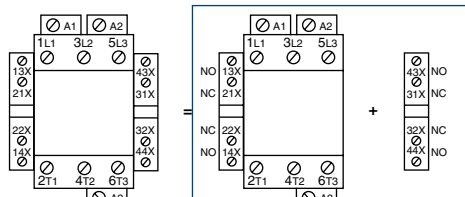

Combination 22 = A50 ... A75-30-11 + CAL5-11

### A145 ... A300 contactors - AC operated

Standard devices with factory mounted auxiliary contacts

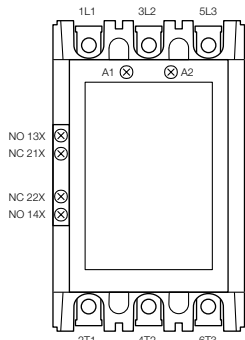

A145 ... A300-30-11

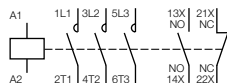

A145 ... A300-30-11

# Star-delta starting of three-phase asynchronous motors

## Contactor selection

### General

Star-delta starting is the most common method to reduce the starting current of a motor. This system can be used on all the squirrel cage motors, which are normally used in delta connection.

In this type of starting, it is recommended to choose motors having high starting torque i.e. much higher than the resistive torque in order to reach sufficient high speed when the motor is connected in star.

3

### Star-delta starting

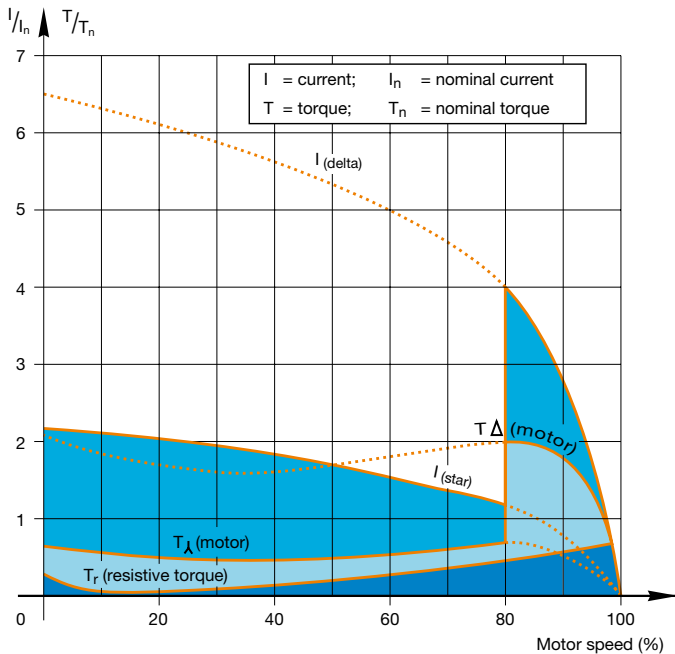

### Technical Data

When starting:

- inrush current is reduced to a third of direct starting current
- motor torque is reduced to a third or even less of direct starting torque.

Transient current is generated when switching from star to delta connection.

### Utilization

During the initial starting phase ("star" connection), the resistive torque of the driven load must remain, irrespective of speed, less than the "star" motor torque until "star-delta" switching occurs.

This starting mode is therefore ideal for machines having low starting torque such as:

- pumps
- centrifugal compressors
- wood-working machines, etc.

**In order to prevent a high current peak, at least 85 % of nominal speed must be reached before switching from star to delta.**

### Precautions

Motor nominal voltage in delta connection must be equal to that of the mains.

Example:

A motor for 400 V star-delta starting must be designed for 400 V in "delta" connection. Its usual designation is "400 V / 690 V motor". The motor must be constructed with 6 terminal windings.

### Sequence

Starting is a three-stage process:

#### 1st stage - "Star" connection

Press the "On" button on the control circuit to close the KM2 "star" contactor. The KM1 "line" contactor then closes and the motor starts. Countdown of programmed starting time (normally 6 to 10 s) then begins.

#### 2nd stage - "Star" to "Delta" switching

When the programmed starting time is over, the KM2 "star" contactor opens.

#### 3rd stage - "Delta" connection

A transition time (or dwelling time) of 50 ms is fixed between opening of the "star" contactor and closing of the "delta" contactor by the use of TE5S timer. This prevents short circuit between "star" and "delta".

Note: An electrical interlock between star and delta is mandatory such as VE 5 or through auxiliary contacts.

Furthermore, in open transition, the current interruption may reach up to 95 ms: it shall be checked that this duration is compatible with the application i.e. mainly if the decreasing in rotation speed is acceptable during the starting phase.

# Star-delta starting of three-phase asynchronous motors

## Contactor selection

Rated operational power (1)					Max. starting time from a cold state (2)	Line contactor KM1	Delta contactor KM3	Star contactor KM2	Overload relay (3)	Timer
230 V AC-3 kW	400 V AC-3 kW	415 V AC-3 kW	500 V AC-3 kW	690 V AC-3 kW						
4	7.5	7.5	5.5	5.5	15	A9	A9	A9	TA25DU-M	TE5S
5.5	11	11	7.5	7.5	15	A12	A12	A9	TA25DU-M	TE5S
9	15	15	15	11	15	A16	A16	A12	TA25DU-M	TE5S
12.5	22	22	22	15	15	A26	A26	A16	TA25DU-M	TE5S
15	25	25	25	18.5	15	A30	A30	A26	TA25DU-M	TE5S
18.5	37	37	37	37	30	A40	A40	A26	TA42DU-M	TE5S
25	45	45	45	45	30	A50	A50	A30	TA75DU-M	TE5S
30	55	55	63	59	30	A63	A63	A40	TA75DU-M	TE5S
37	63	70	75	63	30	A75	A75	A50	TA75DU-M	TE5S
45	75	75	90	90	20	A95	A95	A75	TA110DU	TE5S
55	90	100	110	132	20	A110	A110	A95	TA110DU	TE5S
75	132	132	160	160	20	A145	A145	A110	TA200DU	TE5S
90	160	160	200	250	20	A185	A185	A145	TA200DU	TE5S
110	200	200	250	315	20	A210	A210	A185	TA450DU	TE5S
140	220	250	295	355	20	A260	A260	A210	TA450DU	TE5S
160	250	250	355	450	20	A300	A300	A260	TA450DU	TE5S

- Notes:
- (1) Ambient temperature ≤ 55 °C for A9 ... A300
  - (2) Usual time value = 6...10 s.
  - (3) The setting current value is: nominal motor current x 0.58.

For motors above 670 kW / 400 V, it is recommended to use Closed Transition Star-Delta starting. Contact your ABB Office for selection.

### Power circuit diagram

A9 ... A300 contactors

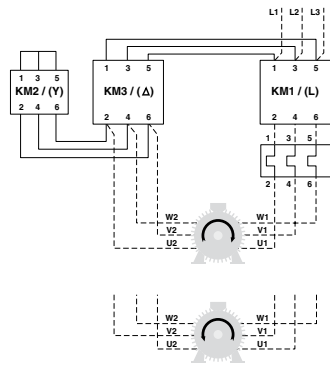

### Control circuit diagrams - Remote control

A9 ... A300 contactors

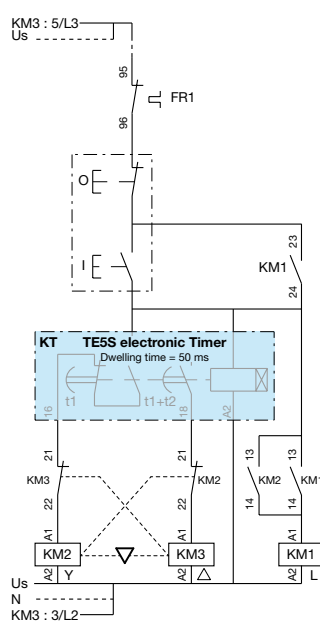

# 4-pole contactors

3



IEC	AC-1 Rated operational current	$\theta \leq 40\text{ }^\circ\text{C}$ , 690 V	A	25	30	45	70	100	125
UL/CSA	General use rating	600 V	A	21	30	40	65	80	105
<b>AC Control supply</b>			Type	A9	A16	A26	A45	A50	A75
IEC	AC-1 Rated operational current	$\theta \leq 40\text{ }^\circ\text{C}$	A	25	30	45	70	100	125
		$\theta \leq 55\text{ }^\circ\text{C}$	A	22	27	40	60	85	105
		$\theta \leq 70\text{ }^\circ\text{C}$	A	18	23	32	50	70	85
	With conductor cross sectional area		mm <sup>2</sup>	2.5	4	6	25	35	50
	Rated operational voltage Ue max.		V	690	690	690	1000	1000	1000

## Main accessories

<b>Auxiliary contact blocks</b>	Front mounting	CA5-10 (1 x N.O.) CA5-01 (1 x N.C.)
	Side mounting	CAL5-11 (1 x N.O. + 1 x N.C.)
<b>Timers</b>	Electronic	TEF5-ON TEF5-OFF
		TE5S (for star-delta starters - direct timing - separate mounting)
<b>Interlocking units</b>	Mechanical	VM5-1
	Mechanical / Electrical	VE5-1   VE5-2
<b>Surge suppressors</b>	Varistor (AC / DC)	RV5 (24...440 V)
	RC Type (AC)	RC5-1 (24...440 V)   RC5-2 (24...440 V)

# A9 ... A16 4-pole contactors

## 25 to 30 A AC-1

### AC operated



A9-40-00

#### Description

A9 ... A16 4-pole contactors are mainly used for controlling non-inductive or slightly inductive loads (i.e. resistance furnaces...) and generally for controlling power circuits up to 690 V AC and 440 V DC.

These contactors are of the block type design with:

- 4 main poles
- control circuit: AC operated
- add-on auxiliary contact blocks for front or side mounting and a wide range of accessories.

#### Ordering details

IEC Rated operational current $\theta \leq 40^\circ\text{C}$ AC-1	UL/CSA General use rating 600 V AC	Rated control circuit voltage $U_c$ (1)		Auxiliary contacts fitted	Type	Order code	Weight  Pkg (1 pce)  kg
A	A	V 50 Hz	V 60 Hz				
<b>4 N.O. main poles</b>							
25	21	24	24	0 0	A9-40-00	1SBL141201R8100	0.340
		48	48	0 0	A9-40-00	1SBL141201R8300	0.340
		110	110...120	0 0	A9-40-00	1SBL141201R8400	0.340
		220...230	230...240	0 0	A9-40-00	1SBL141201R8000	0.340
		230...240	240...260	0 0	A9-40-00	1SBL141201R8800	0.340
		380...400	400...415	0 0	A9-40-00	1SBL141201R8500	0.340
		400...415	415...440	0 0	A9-40-00	1SBL141201R8600	0.340
30	30	24	24	0 0	A16-40-00	1SBL181201R8100	0.340
		48	48	0 0	A16-40-00	1SBL181201R8300	0.340
		110	110...120	0 0	A16-40-00	1SBL181201R8400	0.340
		220...230	230...240	0 0	A16-40-00	1SBL181201R8000	0.340
		230...240	240...260	0 0	A16-40-00	1SBL181201R8800	0.340
		380...400	400...415	0 0	A16-40-00	1SBL181201R8500	0.340
		400...415	415...440	0 0	A16-40-00	1SBL181201R8600	0.340
<b>2 N.O. + 2 N.C. main poles (2)</b>							
25	21	24	24	0 0	A9-22-00	1SBL141501R8100	0.340
		48	48	0 0	A9-22-00	1SBL141501R8300	0.340
		110	110...120	0 0	A9-22-00	1SBL141501R8400	0.340
		220...230	230...240	0 0	A9-22-00	1SBL141501R8000	0.340
		230...240	240...260	0 0	A9-22-00	1SBL141501R8800	0.340
		380...400	400...415	0 0	A9-22-00	1SBL141501R8500	0.340
		400...415	415...440	0 0	A9-22-00	1SBL141501R8600	0.340
30	30	24	24	0 0	A16-22-00	1SBL181501R8100	0.340
		48	48	0 0	A16-22-00	1SBL181501R8300	0.340
		110	110...120	0 0	A16-22-00	1SBL181501R8400	0.340
		220...230	230...240	0 0	A16-22-00	1SBL181501R8000	0.340
		230...240	240...260	0 0	A16-22-00	1SBL181501R8800	0.340
		380...400	400...415	0 0	A16-22-00	1SBL181501R8500	0.340
		400...415	415...440	0 0	A16-22-00	1SBL181501R8600	0.340

(1) Other control voltages see voltage code table.

(2) These contactors are not suitable for a reversing starter or star-delta starter or for controlling a single load from 2 separate supplies. Please see technical data.

#### Main dimensions mm, inches

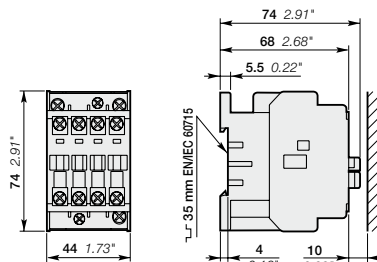

A9, A16

# A26 4-pole contactors

## 45 A AC-1

### AC operated



1SBC570081FC001

3

A26-40-00

#### Description

A26 4-pole contactors are mainly used for controlling non-inductive or slightly inductive loads (i.e. resistance furnaces...) and generally for controlling power circuits up to 690 V AC and 220 V DC.

These contactors are of the block type design with:

- 4 main poles
- control circuit: AC operated
- add-on auxiliary contact blocks for front or side mounting and a wide range of accessories.

#### Ordering details

IEC Rated operational current $\theta \leq 40^\circ\text{C}$ AC-1	UL/CSA General use rating 600 V AC	Rated control circuit voltage $U_c$ (1)		Auxiliary contacts fitted	Type	Order code	Weight  Pkg (1 pce)  kg
A	A	V 50 Hz	V 60 Hz				
<b>4 N.O. main poles</b>							
45	40	24	24	0 0	A26-40-00	1SBL241201R8100	0.610
		48	48	0 0	A26-40-00	1SBL241201R8300	0.610
		110	110...120	0 0	A26-40-00	1SBL241201R8400	0.610
		220...230	230...240	0 0	A26-40-00	1SBL241201R8000	0.610
		230...240	240...260	0 0	A26-40-00	1SBL241201R8800	0.610
		380...400	400...415	0 0	A26-40-00	1SBL241201R8500	0.610
		400...415	415...440	0 0	A26-40-00	1SBL241201R8600	0.610
<b>2 N.O. + 2 N.C. main poles (2)</b>							
45	40	24	24	0 0	A26-22-00	1SBL241501R8100	0.610
		48	48	0 0	A26-22-00	1SBL241501R8300	0.610
		110	110...120	0 0	A26-22-00	1SBL241501R8400	0.610
		220...230	230...240	0 0	A26-22-00	1SBL241501R8000	0.610
		230...240	240...260	0 0	A26-22-00	1SBL241501R8800	0.610
		380...400	400...415	0 0	A26-22-00	1SBL241501R8500	0.610
		400...415	415...440	0 0	A26-22-00	1SBL241501R8600	0.610

(1) Other control voltages see voltage code table.

(2) These contactors are not suitable for a reversing starter or star-delta starter or for controlling a single load from 2 separate supplies. Please see technical data.

#### Main dimensions mm, inches

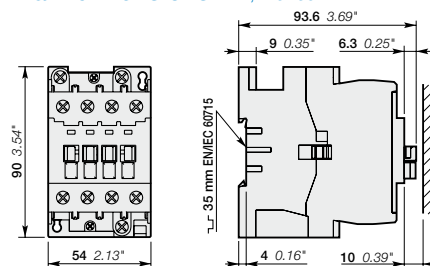

A26

1SBC101863S0201



# A45 ... A75 4-pole contactors

## 70 to 125 A AC-1

### AC operated



A45-40-00

#### Description

A45 ... A75 4-pole contactors are mainly used for controlling non-inductive or slightly inductive loads (i.e. resistance furnaces...) and generally for controlling power circuits up to 690 V AC and 220 V DC.

These contactors are of the block type design with:

- 4 main poles
- control circuit: AC operated
- add-on auxiliary contact blocks for front or side mounting and a wide range of accessories.

#### Ordering details

IEC	UL/CSA	Rated control circuit voltage $U_c$		Auxiliary contacts fitted	Type	Order code	Weight
Rated operational current $\theta \leq 40^\circ\text{C}$ AC-1	General use rating 600 V AC	V 50 Hz	V 60 Hz				Pkg (1 pce) kg

#### 4 N.O. main poles

Rated operational current	General use rating	V 50 Hz	V 60 Hz	NO	NC	Type	Order code	Weight
70	65	24	24	0	0	A45-40-00	1SBL331201R8100	1.390
		48	48	0	0	A45-40-00	1SBL331201R8300	1.390
		110	110...120	0	0	A45-40-00	1SBL331201R8400	1.390
		220...230	230...240	0	0	A45-40-00	1SBL331201R8000	1.390
		230...240	240...260	0	0	A45-40-00	1SBL331201R8800	1.390
		380...400	400...415	0	0	A45-40-00	1SBL331201R8500	1.390
		400...415	415...440	0	0	A45-40-00	1SBL331201R8600	1.390
100	80	24	24	0	0	A50-40-00	1SBL351201R8100	1.390
		48	48	0	0	A50-40-00	1SBL351201R8300	1.390
		110	110...120	0	0	A50-40-00	1SBL351201R8400	1.390
		220...230	230...240	0	0	A50-40-00	1SBL351201R8000	1.390
		230...240	240...260	0	0	A50-40-00	1SBL351201R8800	1.390
		380...400	400...415	0	0	A50-40-00	1SBL351201R8500	1.390
		400...415	415...440	0	0	A50-40-00	1SBL351201R8600	1.390
125	105	24	24	0	0	A75-40-00	1SBL411201R8100	1.390
		48	48	0	0	A75-40-00	1SBL411201R8300	1.390
		110	110...120	0	0	A75-40-00	1SBL411201R8400	1.390
		220...230	230...240	0	0	A75-40-00	1SBL411201R8000	1.390
		230...240	240...260	0	0	A75-40-00	1SBL411201R8800	1.390
		380...400	400...415	0	0	A75-40-00	1SBL411201R8500	1.390
		400...415	415...440	0	0	A75-40-00	1SBL411201R8600	1.390

#### 2 N.O. + 2 N.C. main poles (2)

Rated operational current	General use rating	V 50 Hz	V 60 Hz	NO	NC	Type	Order code	Weight
70	65	24	24	0	0	A45-22-00	1SBL331501R8100	1.400
		48	48	0	0	A45-22-00	1SBL331501R8300	1.400
		110	110...120	0	0	A45-22-00	1SBL331501R8400	1.400
		220...230	230...240	0	0	A45-22-00	1SBL331501R8000	1.400
		230...240	240...260	0	0	A45-22-00	1SBL331501R8800	1.400
		380...400	400...415	0	0	A45-22-00	1SBL331501R8500	1.400
		400...415	415...440	0	0	A45-22-00	1SBL331501R8600	1.400
125	105	24	24	0	0	A75-22-00	1SBL411501R8100	1.400
		48	48	0	0	A75-22-00	1SBL411501R8300	1.400
		110	110...120	0	0	A75-22-00	1SBL411501R8400	1.400
		220...230	230...240	0	0	A75-22-00	1SBL411501R8000	1.400
		230...240	240...260	0	0	A75-22-00	1SBL411501R8800	1.400
		380...400	400...415	0	0	A75-22-00	1SBL411501R8500	1.400
		400...415	415...440	0	0	A75-22-00	1SBL411501R8600	1.400

(1) Other control voltages see voltage code table.

(2) These contactors are not suitable for a reversing starter or star-delta starter or for controlling a single load from 2 separate supplies. Please see technical data.

#### Main dimensions mm, inches

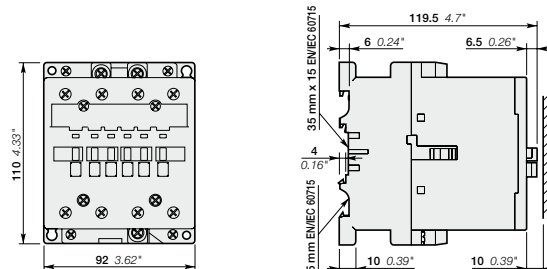

A45, A50, A75

# A9 ... A75 4-pole contactors

## Main accessories

### Contactor and main accessories (other accessories available)

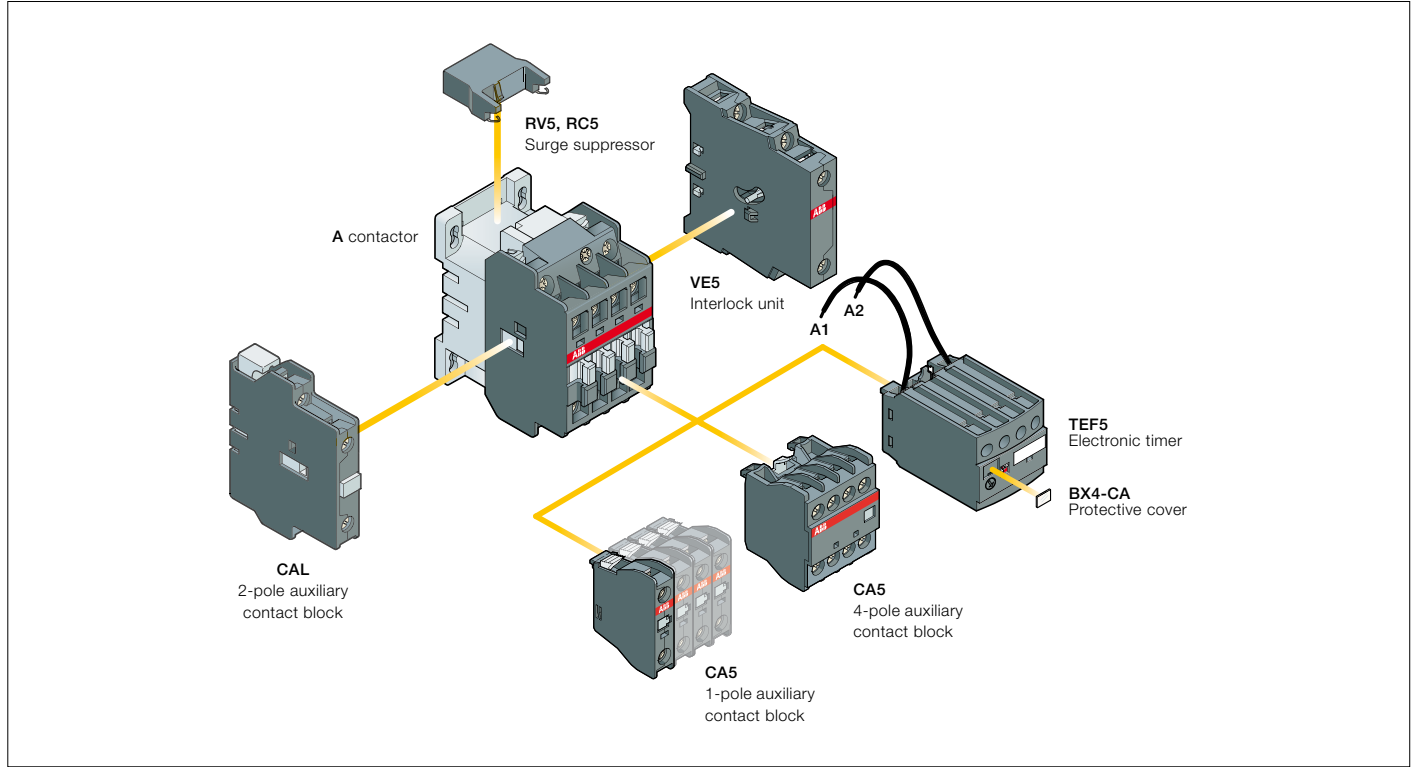

### Main accessory fitting details

Many configurations of accessories are possible depending on whether these are front-mounted or side-mounted.

Contactor types	Main poles	Built-in auxiliary contacts	Front-mounted accessories			Side-mounted accessories		
			Auxiliary contact blocks		Electronic timer	Auxiliary contact blocks	Interlock unit	
			1-pole CA5	4-pole CA5	TEF5		VM5 or VE5	
A9, A16	4 0	0 0	1 to 4 x CA5	or 1 x CA5 (4-pole)	or 1 x TEF5	+	1 to 2 x CAL5-11	or 1 x VM5-1 or VE5-1 + 1 x CAL5-11
	2 2	0 0 (1)	1 to 4 x CA5	or 1 x CA5 (4-pole)	or 1 x TEF5	+	1 to 2 x CAL5-11	–
A26	4 0	0 0	1 to 4 x CA5	or 1 x CA5 (4-pole)	or 1 x TEF5	+	1 to 2 x CAL5-11	or 1 x VM5-1 or VE5-1 + 1 x CAL5-11
	2 2	0 0 (1)	1 to 4 x CA5	or 1 x CA5 (4-pole)	or 1 x TEF5	+	1 to 2 x CAL5-11	–
A45 ... A75	4 0	0 0	1 to 6 x CA5	or 1 x CA5 (4-pole) + 2 x 1-pole CA5	or 1 x TEF5 + 2 x CA5 (1-pole)	+	1 to 2 x CAL5-11	or 1 x VE5-2 + 1 x CAL5-11
	2 2	0 0 (2)	1 to 6 x CA5	or 1 x CA5 (4-pole) + 2 x 1-pole CA5	or 1 x TEF5 + 2 x CA5 (1-pole)	+	1 to 2 x CAL5-11	–

(1) 2 N.C. CA5 auxiliary contacts maximum in mounting position 5.

(2) 2 N.C. CA5 auxiliary contacts maximum.

# A9 ... A75 4-pole contactors

## Main accessories



CA5-10



CAL5-11

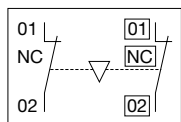

VE5-2

Terminal marking and positioning



TEF5-OFF



RV5/50

### Ordering details (1)

For contactors	Auxiliary contacts	Type	Order code	Pkg qty	Weight (1 pce)
					kg

#### Front-mounted instantaneous auxiliary contact blocks

A9 ... A75	1 -	CA5-10	1SBN010010R1010	10	0.014
	- 1	CA5-01	1SBN010010R1001	10	0.014
A9 ... A75	2 2	CA5-22E	1SBN010040R1022	2	0.060

#### Side-mounted instantaneous auxiliary contact block

A9 ... A75	1 1	CAL5-11	1SBN010020R1011	2	0.050
------------	-----	---------	-----------------	---	-------

#### Interlock units

A9 ... A26	Mechanical	- -	VM5-1	1SBN030100R1000	1	0.066
	Mechanical and electrical	- 2	VE5-1	1SBN030110R1000	1	0.076
A45 ... A75	Mechanical and electrical	- 2	VE5-2	1SBN030210R1000	1	0.146

For contactors	Time delay range selected by switch	Delay type	Auxiliary contacts	Type	Order code	Pkg qty	Weight (1 pce)
							kg

#### Electronic timers

A9 ... A75	0.1...1 s	ON-delay	1 1	TEF5-ON	1SBN020312R1000	1	0.065
	1...10 s						
	10...100 s	OFF-delay	1 1	TEF5-OFF	1SBN020314R1000	1	0.065

Note: Rated control circuit voltage  $U_c$  24...240 V 50/60 Hz or DC.

For contactors	Rated control circuit voltage $U_c$		Type	Order code	Pkg qty	Weight (1 pce)
	V	AC DC				
						kg

#### Surge suppressors

A9 ... A75	24...50	● ●	RV5/50	1SBN050010R1000	2	0.015
	50...133	● ●	RV5/133	1SBN050010R1001	2	0.015
	110...250	● ●	RV5/250	1SBN050010R1002	2	0.015
	250...440	● ●	RV5/440	1SBN050010R1003	2	0.015
A9 ... A26	24...50	● -	RC5-1/50	1SBN050100R1000	2	0.012
	50...133	● -	RC5-1/133	1SBN050100R1001	2	0.012
	110...250	● -	RC5-1/250	1SBN050100R1002	2	0.012
	250...440	● -	RC5-1/440	1SBN050100R1003	2	0.012
A45 ... A75	24...50	● -	RC5-2/50	1SBN050200R1000	2	0.015
	50...133	● -	RC5-2/133	1SBN050200R1001	2	0.015
	110...250	● -	RC5-2/250	1SBN050200R1002	2	0.015
	250...440	● -	RC5-2/440	1SBN050200R1003	2	0.015

(1) See "Main accessory fitting details" table.

# A9 ... A26 4-pole contactors

## Technical data

### Main pole - Utilization characteristics according to IEC

Contactor types	AC operated	A9	A16	A26
Standards		IEC 60947-1 / 60947-4-1 and EN 60947-1 / 60947-4-1		
Rated operational voltage $U_e$ max.		690 V		
Rated frequency (without derating)		50 / 60 Hz		
Conventional free-air thermal current $I_{th}$				
acc. to IEC 60947-4-1, open contactors, $\theta \leq 40^\circ\text{C}$		26 A	30 A	45 A
With conductor cross-sectional area		4 mm <sup>2</sup>	4 mm <sup>2</sup>	6 mm <sup>2</sup>
AC-1 Utilization category				
For air temperature close to contactor				
$I_e$ / Rated operational current AC-1	$\theta \leq 40^\circ\text{C}$	25 A	30 A	45 A
$U_e$ max. $\leq 690$ V, 50/60 Hz	$\theta \leq 55^\circ\text{C}$	22 A	27 A	40 A
	$\theta \leq 70^\circ\text{C}$	18 A	23 A	32 A
With conductor cross-sectional area		2.5 mm <sup>2</sup>	4 mm <sup>2</sup>	6 mm <sup>2</sup>
AC-3 Utilization category				
For air temperature close to contactor $\theta \leq 55^\circ\text{C}$				
$I_e$ / Max. rated operational current AC-3 (1)				
	220-230-240 V	9 A	17 A	26 A
	380-400 V	9 A	17 A	26 A
	415 V	9 A	17 A	26 A
	440 V	9 A	16 A	26 A
	500 V	9 A	14 A	22 A
	690 V	7 A	10 A	17 A
Rated operational power AC-3 (1)				
	220-230-240 V	2.2 kW	4 kW	6.5 kW
	380-400 V	4 kW	7.5 kW	11 kW
	415 V	4 kW	9 kW	11 kW
	440 V	4 kW	9 kW	15 kW
	500 V	5.5 kW	9 kW	15 kW
	690 V	5.5 kW	9 kW	15 kW
Rated making capacity AC-3		10 x $I_e$ AC-3 acc. to IEC 60947-4-1		
Rated breaking capacity AC-3		8 x $I_e$ AC-3 acc. to IEC 60947-4-1		
Short-circuit protection device for contactors				
without thermal overload relay - Motor protection excluded				
$U_e \leq 500$ V AC - gG type fuse		25 A	32 A	50 A
Rated short-time withstand current $I_{cw}$				
at $40^\circ\text{C}$ ambient temperature, in free air from a cold state	1 s	250 A	300 A	400 A
	10 s	100 A	140 A	210 A
	30 s	60 A	80 A	110 A
	1 min	50 A	60 A	90 A
	15 min	26 A	30 A	45 A
Power dissipation per pole				
	$I_e$ / AC-1	0.8 W	1.2 W	1.8 W
	$I_e$ / AC-3	0.1 W	0.35 W	0.6 W
Max. electrical switching frequency				
	AC-1	600 cycle/h		
	AC-3	1200 cycle/h		

(1) For the corresponding kW/A or hp/A values of 1500 r.p.m, 50 Hz or 1800 r.p.m, 60 Hz, 3-phase motors, see "Motor rated operational powers and currents".



### Main pole - Utilization characteristics according to UL / CSA

Contactor types	AC operated	A9	A16	A26
Standards		UL 508, CSA C22.2 N°14		
Max. operational voltage		600 V		
UL / CSA general use rating				
600 V AC		21 A	30 A	40 A
With conductor cross-sectional area		AWG 10		AWG 8
Max. electrical switching frequency		600 cycles/h		
For general use				

# A45 ... A75 4-pole contactors

## Technical data

### Main pole - Utilization characteristics according to IEC

Contactor types	AC operated	A45	A50	A75
Standards		IEC 60947-1 / 60947-4-1 and EN 60947-1 / 60947-4-1		
Rated operational voltage U <sub>e</sub> max.		1000 V		
Rated frequency (without derating)		50 / 60 Hz		
Conventional free-air thermal current I <sub>th</sub> acc. to IEC 60947-4-1, open contactors, $\theta \leq 40\text{ °C}$ With conductor cross-sectional area		100 A 35 mm <sup>2</sup>	100 A 35 mm <sup>2</sup>	125 A 50 mm <sup>2</sup>
<b>AC-1 Utilization category</b> For air temperature close to contactor <b>I<sub>e</sub> / Rated operational current AC-1</b> U <sub>e</sub> max. $\leq 690\text{ V}$ , 50/60 Hz				
	$\theta \leq 40\text{ °C}$	70 A	100 A	125 A
	$\theta \leq 55\text{ °C}$	60 A	85 A	105 A
	$\theta \leq 70\text{ °C}$	50 A	70 A	85 A
	With conductor cross-sectional area	25 mm <sup>2</sup>	35 mm <sup>2</sup>	50 mm <sup>2</sup>
<b>AC-3 Utilization category</b> For air temperature close to contactor $\theta \leq 55\text{ °C}$ <b>I<sub>e</sub> / Max. rated operational current AC-3 (1)</b>				
	220-230-240 V	40 A	53 A	75 A
	380-400 V	37 A	50 A	75 A
	415 V	37 A	50 A	75 A
	440 V	37 A	45 A	70 A
	500 V	33 A	45 A	65 A
	690 V	25 A	35 A	46 A
	1000 V	–	23 A	28 A
 3-phase motors				
<b>Rated operational power AC-3 (1)</b>				
	220-230-240 V	11 kW	15 kW	22 kW
	380-400 V	18.5 kW	22 kW	37 kW
	415 V	18.5 kW	25 kW	40 kW
	440 V	22 kW	25 kW	40 kW
	500 V	22 kW	30 kW	45 kW
	690 V	22 kW	30 kW	40 kW
	1000 V	–	30 kW	37 kW
 1500 r.p.m. 50 Hz 1800 r.p.m. 60 Hz 3-phase motors				
<b>Rated making capacity AC-3</b>		10 x I <sub>e</sub> AC-3 acc. to IEC 60947-4-1		
<b>Rated breaking capacity AC-3</b>		8 x I <sub>e</sub> AC-3 acc. to IEC 60947-4-1		
<b>Short-circuit protection device for contactors</b> without thermal overload relay - Motor protection excluded U <sub>e</sub> $\leq 500\text{ V AC}$ - gG type fuse		80 A	100 A	160 A
<b>Rated short-time withstand current I<sub>cw</sub></b> at 40 °C ambient temperature, in free air from a cold state				
	1 s	1000 A		
	10 s	650 A		
	30 s	370 A		
	1 min	250 A		
	15 min	110 A	110 A	135 A
<b>Power dissipation per pole</b>				
	I <sub>e</sub> / AC-1	2.5 W	5 W	7 W
	I <sub>e</sub> / AC-3	0.65 W	1.3 W	2 W
<b>Max. electrical switching frequency</b>				
	AC-1	600 cycles/h		
	AC-3	600 cycles/h		

(1) For the corresponding kW/A or hp/A values of 1500 r.p.m, 50 Hz or 1800 r.p.m, 60 Hz, 3-phase motors, see "Motor rated operational powers and currents".

### Main pole - Utilization characteristics according to UL / CSA

Contactor types	AC operated	A45	A50	A75
Standards		UL 508, CSA C22.2 N°14		
Max. operational voltage		600 V		
UL / CSA general use rating 600 V AC With conductor cross-sectional area		65 A AWG 6	80 A AWG 4	105 A AWG 2
Max. electrical switching frequency For general use		600 cycles/h		

# A9 ... A26 4-pole contactors

## Technical data

### Magnet system characteristics

Contactor types		AC operated	A9	A16	A26
Coil operating limits		AC supply	at $\theta \leq 55^\circ\text{C}$ $0.85 \dots 1.1 \times U_c$ Please also refer to "Mounting characteristics and conditions for use"		
acc. to IEC 60947-4-1					
AC control voltage 50/60 Hz					
Rated control circuit voltage $U_c$		at 50 Hz	24...690 V		
		at 60 Hz	24...690 V		
Coil consumption	Average pull-in value	50 Hz	70 VA		120 VA
		60 Hz	80 VA		140 VA
		50/60 Hz (1)	74 VA / 70 VA		125 VA / 120 VA
Average holding value		50 Hz	8 VA / 2 W		12 VA / 3 W
		60 Hz	8 VA / 2 W		12 VA / 3 W
		50/60 Hz (1)	8 VA / 2 W		12 VA / 3 W
Drop-out voltage			approx. 40...65 % of $U_c$		
Operating time					
Between coil energization and:	N.O. contact closing		10...26 ms		8...21 ms
	N.C. contact opening		7...21 ms		6...18 ms
Between coil de-energization and:	N.O. contact opening		4...11 ms		4...11 ms
	N.C. contact closing		9...16 ms		7...14 ms

(1) 50/60 Hz coils: see "Coil voltage code table".

### Mounting characteristics and conditions for use

Contactor types		AC operated	A9	A16	A26
Mounting positions					
			Max. N.O. or N.C. built-in and add-on N.O. or N.C. auxiliary contacts: see accessory fitting details for 4-pole contactor A9 ... A26		
Control voltage / Ambient temperature					
Mounting positions	1, $1 \pm 30^\circ$ , 2, 3, 4, 5	at $\theta \leq 55^\circ\text{C}$	$0.85 \dots 1.1 \times U_c$		
		at $\theta \leq 70^\circ\text{C}$	$U_c$		
		at $\theta \leq 55^\circ\text{C}$	$0.95 \dots 1.1 \times U_c$		
		at $\theta \leq 70^\circ\text{C}$	unauthorized		
Mounting distances			The contactors can be assembled side by side		
Fixing					
On rail according to IEC 60715, EN 60715			35 x 7.5 mm or 35 x 15 mm		
By screws (not supplied)			2 x M4 screws placed diagonally		

# A45 ... A75 4-pole contactors

## Technical data

### Magnet system characteristics

Contactor types		AC operated	A45	A50	A75
Coil operating limits		AC supply	At $\theta \leq 55^\circ\text{C}$ $0.85 \dots 1.1 \times U_c$		
acc. to IEC 60947-4-1			Please also refer to "Mounting characteristics and conditions for use"		
AC control voltage					
Rated control circuit voltage $U_c$		at 50 Hz	24...690 V		
		at 60 Hz	24...690 V		
Coil consumption	Average pull-in value	50 Hz	180 VA		
		60 Hz	210 VA		
		50/60 Hz (1)	190 VA / 180 VA		
Coil consumption	Average holding value	50 Hz	18 VA / 5.5 W		
		60 Hz	18 VA / 5.5 W		
		50/60 Hz (1)	18 VA / 5.5 W		
Drop-out voltage			approx. 40...65 % of $U_c$		
Operating time					
Between coil energization and:		N.O. contact closing	8...27 ms		
		N.C. contact opening	7...22 ms		
Between coil de-energization and:		N.O. contact opening	4...11 ms		
		N.C. contact closing	7...14 ms		

(1) 50/60 Hz coils: see "Coil voltage code table".

### Mounting characteristics and conditions for use

Contactor types		AC operated	A45	A50	A75
Mounting positions					
			Pos. 5 unauthorized for A45-22-00, A75-22-00		
			Max. add-on N.O. or N.C. auxiliary contacts: see accessory fitting details for 4-pole contactor A45 ... A75		
Control voltage / Ambient temperature					
Mounting positions (1)	1, 1±30°, 2, 3, 4, 5	at $\theta \leq 55^\circ\text{C}$	$0.85 \dots 1.1 \times U_c$		
		at $\theta \leq 70^\circ\text{C}$	$U_c$		
6		at $\theta \leq 55^\circ\text{C}$	$0.95 \dots 1.1 \times U_c$		
		at $\theta \leq 70^\circ\text{C}$	Unauthorized		
Mounting distances			The contactors can be assembled side by side		
Fixing					
On rail according to IEC 60715, EN 60715			35 x 15 mm or 75 x 25 mm		
By screws (not supplied)			2 x M6 screws placed diagonally		

(1) For 60 Hz coil voltage: (only for devices fitted with CA 5-... and CAL 5-11 auxiliary contacts).

– A45-40-00, A50-40-00 and A75-40-00 contactors.

Mounting positions 1 to 5 and ambient temperature  $\leq 55^\circ\text{C}$ : tolerance reduced to  $0.9 \dots 1.1 U_c$  (instead of  $0.85 \dots 1.1 U_c$ ) for coil voltage codes 70 to 79 and 80 to 89.

– A45-22-00 and A75-22-00 contactors.

Mounting positions 1 to 4 and ambient temperature  $\leq 55^\circ\text{C}$ : tolerance reduced to  $0.9 \dots 1.1 U_c$  (instead of  $0.85 \dots 1.1 U_c$ ) for coil voltage codes 70 to 79 and 80 to 89.

For mounting position 6 or ambient temperature of 55 to 70 °C the information given on this page remains applicable.

# A9 ... A26 4-pole contactors

## Technical data

### General technical data

Contactor types	AC operated	A9	A16	A26
<b>Rated insulation voltage <math>U_i</math></b> acc. to IEC 60947-4-1 acc. to UL / CSA		1000 V 600 V		
<b>Rated impulse withstand voltage <math>U_{imp}</math></b>		8 kV		
<b>Ambient air temperature close to contactor</b> Operation in free air Storage		-40...+70 °C -60...+80 °C		
<b>Climatic withstand</b>		acc. to IEC 60068-2-30 and 60068-2-11 - UTE C 63-100 specification II		
<b>Maximum operating altitude (without derating)</b>		3000 m		
<b>Mechanical durability</b> Number of operating cycles Max. switching frequency		10 millions operating cycles 3600 cycles/h		
<b>Shock withstand</b> acc. to IEC 60068-2-27 and EN 60068-2-27 Mounting position 1				
	<b>Shock direction</b>	1/2 sinusoidal shock for 11 ms: no change in contact position, closed or open position		
	A	20 g		
	B1	10 g closed position / 5 g open position		
	B2	15 g		
	C1	20 g		
	C2	20 g		

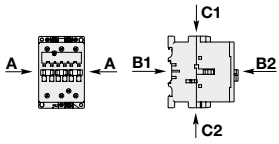

### Remark for 4-pole contactors fitted with 2 N.O. + 2 N.C. main poles

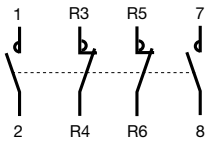

These contactors are suitable for controlling 2 separate circuits, i.e. 2 loads with 2 separate supplies, or 1 circuit comprising 2 separate loads with a single supply (see diagrams below). When the contactor operates there is no mechanical overlapping between the N.O. poles and the N.C. poles: BREAK before MAKE.



These contactors are not suitable for a reversing starter or for controlling a single load from 2 separate supplies.

### Block diagrams

– Single supply and 2 separate loads

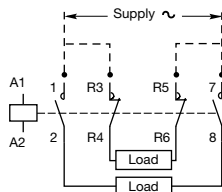

– 2 separate supplies and 2 separate loads

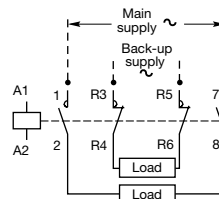



# A45 ... A75 4-pole contactors

## Technical data

### General technical data

Contactor types	AC operated	A45	A50	A75
<b>Rated insulation voltage <math>U_i</math></b> acc. to IEC 60947-4-1 acc. to UL / CSA		1000 V 600 V		
<b>Rated impulse withstand voltage <math>U_{imp}</math></b>		8 kV		
<b>Ambient air temperature close to contactor</b> Operation in free air Storage		-40...+70 °C -60...+80 °C		
<b>Climatic withstand</b>		acc. to IEC 60068-2-30 and 60068-2-11 - UTE C 63-100 specification II		
<b>Maximum operating altitude (without derating)</b>		3000 m		
<b>Mechanical durability</b> Number of operating cycles Max. switching frequency		10 millions operating cycles 3600 cycles/h		
<b>Shock withstand</b> acc. to IEC 60068-2-27 and EN 60068-2-27 Mounting position 1				
	<b>Shock direction</b>	1/2 sinusoidal shock for 11 ms: no change in contact position, closed or open position		
	<b>A</b>	20 g		
	<b>B1</b>	10 g closed position / 5 g open position		
	<b>B2</b>	15 g		
	<b>C1</b>	20 g		
	<b>C2</b>	20 g		

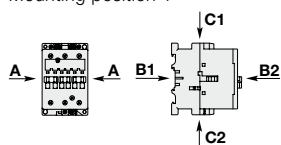

### Remark for 4-pole contactors fitted with 2 N.O. + 2 N.C. main poles

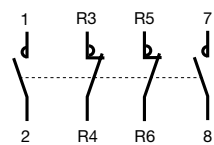

These contactors are suitable for controlling 2 separate circuits, i.e. 2 loads with 2 separate supplies, or 1 circuit comprising 2 separate loads with a single supply (see diagrams below). When the contactor operates there is no mechanical overlapping between the N.O. poles and the N.C. poles: BREAK before MAKE.



These contactors are not suitable for a reversing starter or for controlling a single load from 2 separate supplies.

### Block diagrams

– Single supply and 2 separate loads

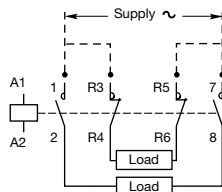



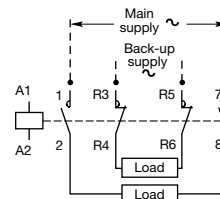



– 2 separate supplies and 2 separate loads



# A9 ... A26 4-pole contactors

## Technical data

### Connecting characteristics











Contactor types	AC operated	A9	A16	A26
Main terminals		 Screw terminals with cable clamp		
Connection capacity (min. ... max.)				
<b>Main conductors (poles)</b>				
 Rigid	Solid ( $\leq 4 \text{ mm}^2$ )	} 1 x 1...4 mm <sup>2</sup> 2 x 1...4 mm <sup>2</sup>	1.5...6 mm <sup>2</sup>	
 Stranded ( $\geq 6 \text{ mm}^2$ )			1.5...6 mm <sup>2</sup>	
 Flexible with ferrule		1 x 0.75...2.5 mm <sup>2</sup> 2 x 0.75...2.5 mm <sup>2</sup>	0.75...4 mm <sup>2</sup> 0.75...4 mm <sup>2</sup>	
Bars or lugs		L < 7.7 mm l < 3.7 mm	10 mm 4.2 mm	
Connection capacity acc. to UL / CSA		1 or 2 x AWG 18...10	AWG 12...8	
Tightening torque		Recommended 1 Nm / 9 lb.in Max. 1.2 Nm	1.7 Nm / 15 lb.in 2.2 Nm	
<b>Auxiliary conductors (coil terminals)</b>				
 Rigid solid		1 x 1...4 mm <sup>2</sup> 2 x 1...4 mm <sup>2</sup>		
 Flexible with ferrule		1 x 0.75...2.5 mm <sup>2</sup> 2 x 0.75...2.5 mm <sup>2</sup>		
Lugs		L < 7.7 mm l < 3.7 mm	(1) (1)	
Connection capacity acc. to UL / CSA		1 or 2 x AWG 18...14		
Tightening torque		Recommended 1 Nm / 9 lb.in Max. 1.2 Nm		
<b>Degree of protection</b>				
acc. to IEC 60947-1 / EN 60947-1 and IEC 60529 / EN 60529				
Main terminals		IP20		
Coil terminals		IP20		
<b>Screw terminals</b>				
Main terminals		Delivered in open position, screws of unused terminals must be tightened		
		M3.5	M4	
		<b>Screwdriver type</b>	Flat Ø 5.5 / Pozidriv 2	
Coil terminals		M3.5		
		<b>Screwdriver type</b>	Flat Ø 5.5 / Pozidriv 2	

(1) L ≤ 8 and l > 3.7 for coil terminals - L ≤ 10 and l > 4.2 for built-in auxiliary terminals.

# A45 ... A75 4-pole contactors

## Technical data

### Connecting characteristics

Contactor types	AC operated	A45	A50	A75
<b>Main terminals</b>				
		Screw terminals with single connector (13 x 10 mm)		
<b>Connection capacity (min. ... max.)</b>				
<b>Main conductors (poles)</b>				
 Rigid Solid ( $\leq 4 \text{ mm}^2$ )	}	1 x	6...50 mm <sup>2</sup>	
 Stranded ( $\geq 6 \text{ mm}^2$ )		2 x	6...25 mm <sup>2</sup>	
 Flexible with ferrule		1 x	6...35 mm <sup>2</sup>	
		2 x	6...16 mm <sup>2</sup>	
 Bars or lugs		L <	-	
		I <	-	
Connection capacity acc. to UL / CSA		1 or 2 x	AWG 8...1	
Tightening torque	Recommended		4.00 Nm / 35 lb.in	
	Max.		4.50 Nm	
<b>Auxiliary conductors</b> (coil terminals)				
 Rigid solid		1 x	1...4 mm <sup>2</sup>	
		2 x	1...4 mm <sup>2</sup>	
 Flexible with ferrule		1 x	1...2.5 mm <sup>2</sup>	
		2 x	0.75...2.5 mm <sup>2</sup>	
 Lugs		L <	8 mm	
		I <	3.7 mm	
Connection capacity acc. to UL / CSA		1 or 2 x	AWG 18...14	
Tightening torque	Recommended		1.00 Nm / 9 lb.in	
	Max.		1.20 Nm	
<b>Degree of protection</b> acc. to IEC 60947-1 / EN 60947-1 and IEC 60529 / EN 60529				
Main terminals			IP10	
Coil terminals			IP20	
<b>Screw terminals</b>			Delivered in open position, screws of unused terminals must be tightened	
Main terminals			M6	
	<b>Screwdriver type</b>		Flat Ø 6.5 / Pozidriv 2	
Coil terminals			M3.5	
	<b>Screwdriver type</b>		Flat Ø 5.5 / Pozidriv 2	

# A9 ... A75 4-pole contactors

## Terminal marking and positioning

### A9 ... A75 contactors - AC operated

Standard devices without addition of auxiliary contacts

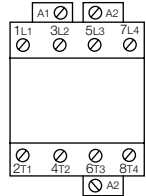

A9 ... A75-40-00

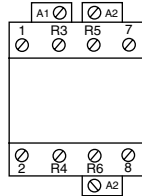

A9 ... A75-22-00

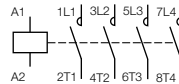

A9 ... A75-40-00

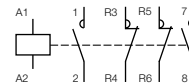

A9 ... A75-22-00

# N 4-pole contactor relays

## AC operated



N40E

### Description

N contactor relays are used for switching auxiliary circuits and control circuits.

These contactor relays are of the block type design with:

- 4 poles. Contactor relays have mechanically linked auxiliary contact elements
- control circuit: AC operated
- add-on auxiliary contact blocks for front or side mounting and a wide range of accessories.

### Ordering details

Number of contacts	Rated control circuit voltage U <sub>c</sub> (1)		Type	Order code	Weight  Pkg (1 pce) kg
	V 50 Hz	V 60 Hz			
	24	24	N22E	1SBH141001R8122	0.340
	48	48	N22E	1SBH141001R8322	0.340
	110	110...120	N22E	1SBH141001R8422	0.340
	220...230	230...240	N22E	1SBH141001R8022	0.340
	230...240	240...260	N22E	1SBH141001R8822	0.340
	380...400	400...415	N22E	1SBH141001R8522	0.340
400...415	415...440	N22E	1SBH141001R8622	0.340	
	24	24	N31E	1SBH141001R8131	0.340
	48	48	N31E	1SBH141001R8331	0.340
	110	110...120	N31E	1SBH141001R8431	0.340
	220...230	230...240	N31E	1SBH141001R8031	0.340
	230...240	240...260	N31E	1SBH141001R8831	0.340
	380...400	400...415	N31E	1SBH141001R8531	0.340
400...415	415...440	N31E	1SBH141001R8631	0.340	
	24	24	N40E	1SBH141001R8140	0.340
	48	48	N40E	1SBH141001R8340	0.340
	110	110...120	N40E	1SBH141001R8440	0.340
	220...230	230...240	N40E	1SBH141001R8040	0.340
	230...240	240...260	N40E	1SBH141001R8840	0.340
	380...400	400...415	N40E	1SBH141001R8540	0.340
400...415	415...440	N40E	1SBH141001R8640	0.340	

(1) Other control voltages see voltage code table.

### Main dimensions mm, inches

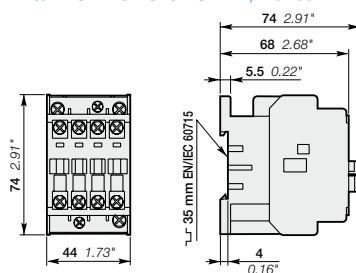

N22E, N31E, N40E

# N 4-pole contactor relays

## Main accessories

### Contactor and main accessories (other accessories available)

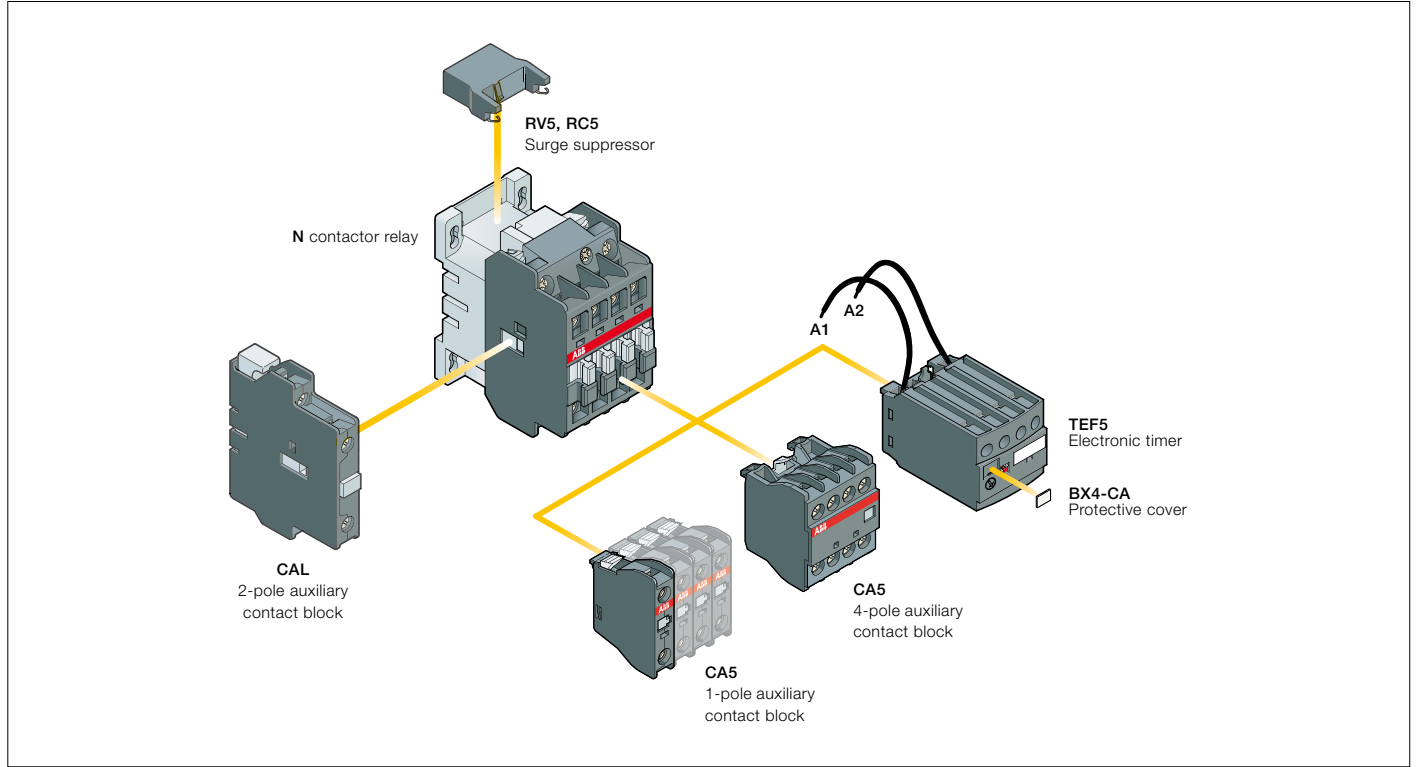

### Main accessory fitting details

Many configurations of accessories are possible depending on whether these are front-mounted or side-mounted.

Contactor types	Main poles	Front-mounted accessories			Side-mounted accessories
		Auxiliary contact blocks		Electronic timer	Auxiliary contact blocks
		1-pole CA5	4-pole CA5	TEF5	2-pole CAL5-11
N	2 2 E (1) 3 1 E (1) 4 0 E	1 to 4 x CA5	or 1 x CA5 (4-pole)	or 1 x TEF5	+ 1 to 2 x CAL5-11

(1) 2 N.C. front mounted auxiliary contacts maximum in mounting position 5.

# N 4-pole contactor relays

## Main accessories



CA5-10



CAL5-11



TEF5-OFF



RV5/50

### Ordering details (1)

For contactors	Auxiliary contacts	Type	Order code	Pkg qty	Weight (1 pce)
					kg

#### Front-mounted instantaneous auxiliary contact blocks

4-pole N	1 -	CA5-10	1SBN010010R1010	10	0.014
	- 1	CA5-01	1SBN010010R1001	10	0.014
	2 2	CA5-22N	1SBN010040R1222	2	0.060

#### Side-mounted instantaneous auxiliary contact block

N	1 1	CAL5-11	1SBN010020R1011	2	0.050
---	-----	---------	-----------------	---	-------

For contactors	Time delay range selected by switch	Delay type	Auxiliary contacts	Type	Order code	Pkg qty	Weight (1 pce)
							kg

#### Electronic timers

4-pole N	0.1...1 s 1...10 s 10...100 s	ON-delay	1 1	TEF5-ON	1SBN020312R1000	1	0.065
		OFF-delay	1 1	TEF5-OFF	1SBN020314R1000	1	0.065

Note: Rated control circuit voltage  $U_c$  24...240 V 50/60 Hz or DC.

For contactors	Rated control circuit voltage $U_c$		Type	Order code	Pkg qty	Weight (1 pce)
	V	AC DC				

#### Surge suppressors

N	24...50	● ●	RV5/50	1SBN050010R1000	2	0.015
	50...133	● ●	RV5/133	1SBN050010R1001	2	0.015
	110...250	● ●	RV5/250	1SBN050010R1002	2	0.015
	250...440	● ●	RV5/440	1SBN050010R1003	2	0.015
N	24...50	● -	RC5-1/50	1SBN050100R1000	2	0.012
	50...133	● -	RC5-1/133	1SBN050100R1001	2	0.012
	110...250	● -	RC5-1/250	1SBN050100R1002	2	0.012
	250...440	● -	RC5-1/440	1SBN050100R1003	2	0.012

(1) See "Main accessory fitting details" table.

# N contactor relays

## Technical data

### Contact utilization characteristics according to IEC

Contact relay types	AC operated	N
<b>Standards</b>		IEC 60947-1 / 60947-5-1 and EN 60947-1 / 60947-5-1
<b>Rated operational voltage <math>U_e</math> max.</b>		690 V
<b>Rated frequency (without derating)</b>		50 / 60 Hz
<b>Conventional free-air thermal current <math>I_{th}</math> <math>\theta \leq 40</math> °C</b>		16 A
<b><math>I_e</math> / Rated operational current AC-15</b>		
acc. to IEC 60947-5-1	24-127 V 50/60 Hz	6 A
	230-240 V 50/60 Hz	4 A
	400-415 V 50/60 Hz	3 A
	500 V 50/60 Hz	2 A
	690 V 50/60 Hz	2 A
<b>Rated making capacity AC-15</b>		10 x $I_e$ AC-15 acc. to IEC 60947-5-1
<b>Rated breaking capacity AC-15</b>		10 x $I_e$ AC-15 acc. to IEC 60947-5-1
<b><math>I_e</math> / Rated operational current DC-13</b>		
acc. to IEC 60947-5-1	24 V DC	6 A / 144 W
	48 V DC	2.8 A / 134 W
	72 V DC	1 A / 72 W
	110 V DC	0.55 A / 60 W
	125 V DC	0.55 A / 69 W
	220 V DC	0.30 A / 66 W
	250 V DC	0.30 A / 75 W
<b>Short-circuit protection device for contactors</b>		
$U_e \leq 500$ V AC - gG type fuse		10 A
<b>Rated short-time withstand current <math>I_{cw}</math></b>		
at 40 °C ambient temperature, in free air from a cold state	for 1.0 s	100 A
	for 0.1 s	140 A
<b>Minimum switching capacity</b>		17 V / 5 mA
with failure rate acc. to IEC 60947-5-4		10 <sup>6</sup>
<b>Non-overlapping time between N.O. and N.C. contacts</b>		$\geq 2$ ms
<b>Power dissipation per pole at 6 A</b>		0.1 W
<b>Max. electrical switching frequency</b>	AC-15	1200 cycles/h

### Contact utilization characteristics according to UL / CSA

Contact relay types	AC operated	N
<b>Standards</b>		UL 508, CSA C22.2 N°14
<b>Max. operational voltage</b>		600 V AC
<b>Pilot duty</b>		A600, Q300

### General technical data

Contact relay types	AC operated	N
<b>Rated insulation voltage <math>U_i</math></b>		
acc. to IEC 60947-5-1		690 V
acc. to UL / CSA		600 V
<b>Rated impulse withstand voltage <math>U_{imp}</math>.</b>		8 kV
<b>Ambient air temperature</b>		
Operation in free air		-40...+70 °C
Storage		-60...+80 °C
<b>Climatic withstand</b>		acc. to IEC 60068-2-30 and 60068-2-11 - UTE C 63-100 specification II
<b>Maximum operating altitude (without derating)</b>		3000 m
<b>Mechanical durability</b>		
Number of operating cycles		$\geq 20$ millions operating cycles
Max. switching frequency		6000 cycles/h
<b>Shock withstand</b>		
acc. to IEC 60068-2-27 and EN 60068-2-27		
Mounting position 1		
	<b>Shock direction</b>	1/2 sinusoidal shock for 11 ms: no change in contact position, closed or open position
	A	20 g
	B1	5 g
	B2	15 g
	C1	20 g
	C2	20 g

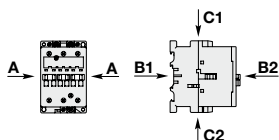



# N contactor relays

## Technical data

### Magnet system characteristics

<b>Contactor relay types</b>	AC operated	<b>N</b>	
<b>Coil operating limits</b> acc. to IEC 60947-4-1	AC supply	at $\theta \leq 55^\circ\text{C}$ 0.85...1.1 x $U_c$ Please also refer to "Mounting characteristics and conditions for use"	
<b>AC control voltage 50/60 Hz</b>			
Rated control circuit voltage $U_c$	at 50 Hz	24...690 V	
	at 60 Hz	24...690 V	
Coil consumption	Average pull-in value	50 Hz	70 VA
		60 Hz	80 VA
		50/60 Hz (1)	74 VA / 70 VA
Average holding value		50 Hz	8 VA / 2 W
		60 Hz	8 VA / 2 W
		50/60 Hz (1)	8 VA / 2 W
<b>Drop-out voltage</b>		approx. 40...65 % of $U_c$	
<b>Operating time</b>			
Between coil energization and:	<b>N.O. contact closing</b>	10...26 ms	
	<b>N.C. contact opening</b>	7...21 ms	
Between coil de-energization and:	<b>N.O. contact opening</b>	4...11 ms	
	<b>N.C. contact closing</b>	9...16 ms	

(1) 50/60 Hz coils: see "Coil voltage code table".

### Mounting characteristics and conditions for use

<b>Contactor relay types</b>	AC operated	<b>N</b>
<b>Mounting positions</b>		
<b>Control voltage / Ambient temperature</b>	Max. N.O. or N.C. built-in and add-on N.O. or N.C. auxiliary contacts: see accessory fitting details for contactor relays	
Mounting positions	1, 1±30°, 2, 3, 4, 5	at $\theta \leq 55^\circ\text{C}$ 0.85...1.1 x $U_c$
		at $\theta \leq 70^\circ\text{C}$ $U_c$
	6	at $\theta \leq 55^\circ\text{C}$ 0.95...1.1 x $U_c$
		> 55°C unauthorized
<b>Mounting distances</b>	The contactors can be assembled side by side	
<b>Fixing</b>		
On rail according to IEC 60715, EN 60715	35 x 7.5 mm or 35 x 15 mm	
By screws (not supplied)	2 x M4 screws placed diagonally	

### Connecting characteristics

<b>Contactor relay types</b>	AC operated	<b>N</b>
<b>Main terminals</b>	<p>Screw terminals with cable clamp</p>	
<b>Connection capacity (min. ... max.)</b>		
<b>Main conductors (poles)</b>	Rigid	1 x 1...4 mm <sup>2</sup>
		2 x 1...4 mm <sup>2</sup>
Flexible with ferrule	1 x	0.75...2.5 mm <sup>2</sup>
	2 x	0.75...2.5 mm <sup>2</sup>
Bars or lugs	Pole terminals	L < 7.7 mm
		I < 3.7 mm
	Coil terminals	L < 8 mm
		I < 3.7 mm
Connection capacity acc. to UL / CSA	1 or 2 x	AWG 18...14
Tightening torque	Recommended	1 Nm / 9 lb.in
	Max.	1.20 Nm
<b>Degree of protection</b> acc. to IEC 60947-1 / EN 60947-1 and IEC 60529 / EN 60529	IP20	
<b>Screw terminals</b>	Delivered in open position, screws of unused terminals must be tightened	
All terminals	M3.5	
<b>Screwdriver type</b>	Flat Ø 5.5 / Pozidriv 2	

# N 4-pole contactor relays

## Terminal marking and positioning

### N contactor relays - AC operated

Standard devices without addition of auxiliary contacts

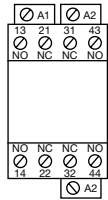

N22E

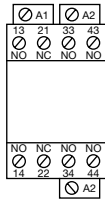

N31E

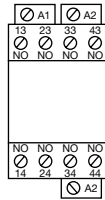

N40E

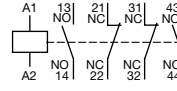

N22E

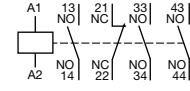

N31E

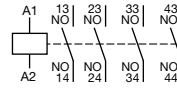

N40E

3

Other possible contact combinations with auxiliary contacts added by the user

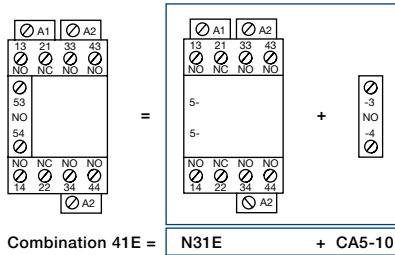

Combination 41E =

N31E + CA5-10

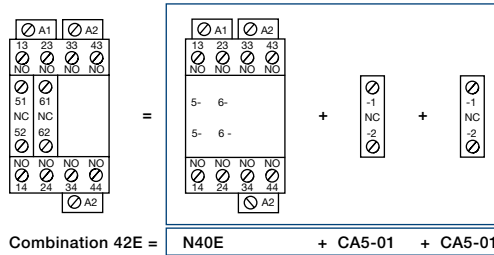

Combination 42E =

N40E + CA5-01 + CA5-01

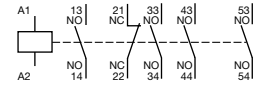

Combination 41E

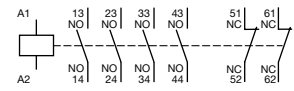

Combination 42E

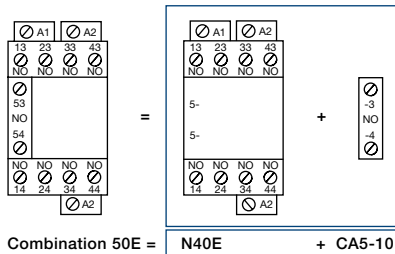

Combination 50E =

N40E + CA5-10

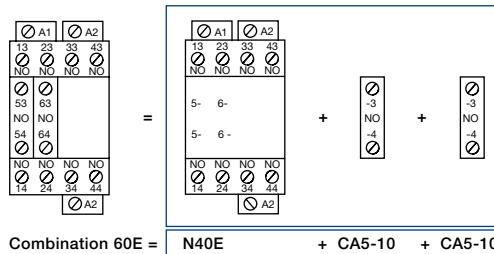

Combination 60E =

N40E + CA5-10 + CA5-10

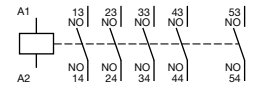

Combination 50E

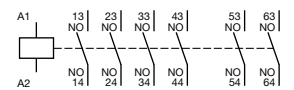

Combination 60E

# Notes

A series of horizontal dotted lines for writing notes, spanning the width of the page.

# Auxiliary contact blocks



CA5-10

3



CA5-40E



CAL5-11



CAL18-11

## Description

The auxiliary contact blocks are used for the operation of auxiliary circuits and control circuits for standard industrial environments.

Types of auxiliary contact blocks for front mounting:

- CA5 1 or 4-pole block, instantaneous with N.O., N.C. contacts
- CC5 1-pole block, with N.O. leading contact or N.C. lagging contact.

Select the 4-pole auxiliary contact blocks CA5 type, according to the contactor type for compliance with the standard requirements (see "Terminal marking and positioning").

Types of auxiliary contact blocks for side mounting:

- CAL 2-pole block instantaneous N.O. + N.C. contacts.

For clipping onto the right- and/or left-hand side of the contactors.

The CAL18-11B is a second block for mounting in addition to a first CAL18-11 block, right- and/or left-hand of the A145 ... A300 contactors.

The auxiliary contact blocks are equipped with screw type connecting terminals delivered open, protected against accidental direct contact and bear the corresponding function marking.

## Ordering details (1)

For contactors	Auxiliary contacts	Type	Order code	Pkg qty	Weight (1 pce)
					kg
<b>Front-mounted instantaneous auxiliary contact blocks, 1-pole</b>					
A9 ... A110	1 0 - -	CA5-10	1SBN010010R1010	10	0.014
N 4-pole	0 1 - -	CA5-01	1SBN010010R1001	10	0.014
	- - 1 0	CC5-10	1SBN010011R1010	10	0.014
	- - 0 1	CC5-01	1SBN010011R1001	10	0.014
<b>Front-mounted instantaneous auxiliary contact blocks, 4-pole</b>					
A9 ... A26-40-00	2 2 - -	CA5-22E	1SBN010040R1022	2	0.060
A9 ... A26-22-00	3 1 - -	CA5-31E	1SBN010040R1031	2	0.060
A45 ... A110	4 0 - -	CA5-40E	1SBN010040R1040	2	0.060
	0 4 - -	CA5-04E	1SBN010040R1004	2	0.060
	1 1 1 1	CA5-11/11E	1SBN010040R1018	2	0.060
A9 ... A40-30-10	2 2 - -	CA5-22M	1SBN010040R1122	2	0.060
	3 1 - -	CA5-31M	1SBN010040R1131	2	0.060
	1 3 - -	CA5-13M	1SBN010040R1113	2	0.060
	0 4 - -	CA5-04M	1SBN010040R1104	2	0.060
	1 1 1 1	CA5-11/11M	1SBN010040R1118	2	0.060
A9 ... A40-30-01	2 2 - -	CA5-22U	1SBN010040R1322	2	0.060
	3 1 - -	CA5-31U	1SBN010040R1331	2	0.060
	4 0 - -	CA5-40U	1SBN010040R1340	2	0.060
	0 4 - -	CA5-04U	1SBN010040R1304	2	0.060
N 4-pole	2 2 - -	CA5-22N	1SBN010040R1222	2	0.060
	3 1 - -	CA5-31N	1SBN010040R1231	2	0.060
	1 3 - -	CA5-13N	1SBN010040R1213	2	0.060
	0 4 - -	CA5-04N	1SBN010040R1204	2	0.060
	4 0 - -	CA5-40N	1SBN010040R1240	2	0.060
<b>Side-mounted instantaneous auxiliary contact blocks, 2-pole</b>					
A9 ... A75	1 1 - -	CAL5-11	1SBN010020R1011	2	0.050
N	- - 1 1	CCL5-11	1SBN011421R1008	2	0.050
A9 ... A16	1 1 - -	CAL18-11	1SFN010720R1011	2	0.050
N	1 1 - -	CAL18-11B	1SFN010720R3311	2	0.050

(1) For each contactor type, refer to "Accessory fitting details" table.  
 (2) 2 blocks CAL18-11 + 2 blocks CAL18-11B.

# Auxiliary contact blocks

## Technical data

Types	<b>Front mounted</b> 1-pole <b>CA5</b> , 1-pole <b>CC5</b> , 4-pole <b>CA5</b>	<b>Side mounted</b> <b>CAL5-11, CCL5-11</b>	<b>CAL18-11, CAL18-11B</b>
-------	--	--	----------------------------



## Contact utilization characteristics according to IEC

Standards	IEC 60947-5-1 and EN 60947-5-1		
Rated insulation voltage $U_i$ acc. to IEC 60947-5-1	690 V		
Rated operational voltage $U_e$ max.	24...690 V AC		
Conventional thermal current $I_{th}$ - $\theta \leq 40^\circ\text{C}$ $I_e$ / Rated operational current AC-15 acc. to IEC 60947-5-1	16 A		
	24-127 V 50/60 Hz	6 A	
	220-240 V 50/60 Hz	4 A	
	380-440 V 50/60 Hz	3 A	
	500-690 V 50/60 Hz	2 A	
Making capacity	10 x $I_e$ AC-15 acc. to IEC 60947-5-1		
Breaking capacity $I_e$ / Rated operational current DC-13 acc. to IEC 60947-5-1	10 x $I_e$ AC-15 acc. to IEC 60947-5-1		
	24 V DC	6 A / 144 W	
	48 V DC	2.8 A / 134 W	
	72 V DC	1 A / 72 W	
	110 V DC	0.55 A / 60 W	
	125 V DC	0.55 A / 69 W	
	220 V DC	0.3 A / 66 W	
	250 V DC	0.3 A / 75 W	
Short-circuit protection device gG type fuse	10 A		
Rated short-time withstand current $I_{cw}$ $\theta = 40^\circ\text{C}$	for 1.0 s	100 A	
	for 0.1 s	140 A	
Minimum switching capacity			
A40 ... A75 contactors with failure rate acc. to IEC 60947-5-4	17 V / 1 mA		-
	$\leq 10^{-7}$		-
A95 ... A110 contactors with failure rate acc. to IEC 60947-5-4	24 V / 50 mA		24 V / 50 mA (0.5 million of operating cycles)
	-	-	$\leq 10^{-6}$
Power dissipation per pole at 6 A	0.1 W		0.15 W
Mechanical durability			
Number of operating cycles	10 millions (A9 ... A75) 3 millions (A95 ... A110)	10 millions	5 millions (A95 ... A185) 3 millions (A210 ... A300)
Max. switching frequency	3600 cycles/h		
Electrical durability			
Number of operating cycles	see "Electrical durability" curves		
Max. switching frequency	AC-15	1200 cycles/h	
	DC-13	900 cycles/h	

## Contact utilization characteristics according to UL / CSA

Standards	UL 508, CSA C22.2 N°14
Max. operational voltage	600 V AC, 250 V DC
Pilot duty	A600, Q300
AC thermal rated current	10 A

## Connecting characteristics

Connection capacity (min. ... max.)			
 Rigid solid	1 x	1...4 mm <sup>2</sup>	
	2 x	1...4 mm <sup>2</sup>	
 Flexible with ferrule	1 x	0.75...2.5 mm <sup>2</sup>	
	2 x	0.75...2.5 mm <sup>2</sup>	
 Lugs	L ≤	7.7 mm	8 mm
	I >	3.7 mm	3.7 mm
Connection capacity acc. to UL / CSA	1 or 2 x	AWG 18...14	
Tightening torque	1 Nm / 9 lb.in		
Degree of protection	Terminals	IP20	
acc. to IEC 60947-1 / EN 60947-1 and IEC 60529 / EN 60529			
Screw terminals	Delivered in open position, screws of unused terminals must be tightened		
All terminals	M3.5		
Screwdriver type	Flat Ø 5.5 / Pozidriv 2		

# Add-on auxiliary contacts

## Terminal marking and positioning

### 1-pole auxiliary contacts

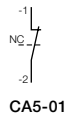

CA5-01

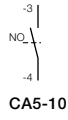

CA5-10



CC5-01

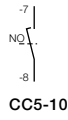

CC5-10

3

### 2-pole auxiliary contacts

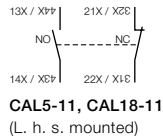

CAL5-11, CAL18-11  
(L. h. s. mounted)

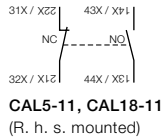

CAL5-11, CAL18-11  
(R. h. s. mounted)

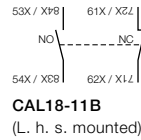

CAL18-11B  
(L. h. s. mounted)

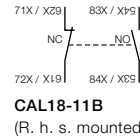

CAL18-11B  
(R. h. s. mounted)

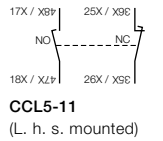

CCL5-11  
(L. h. s. mounted)

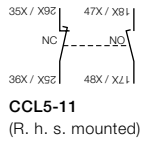

CCL5-11  
(R. h. s. mounted)

### 4-pole auxiliary contacts

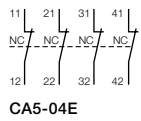

CA5-04E

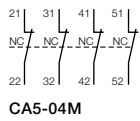

CA5-04M

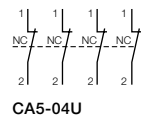

CA5-04U

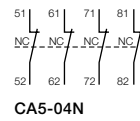

CA5-04N

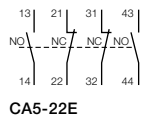

CA5-22E

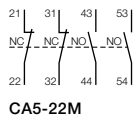

CA5-22M

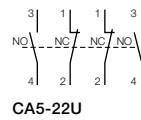

CA5-22U

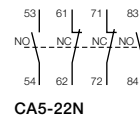

CA5-22N

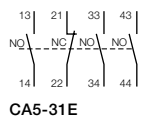

CA5-31E

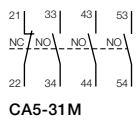

CA5-31M

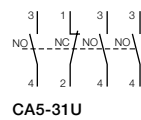

CA5-31U

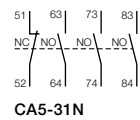

CA5-31N

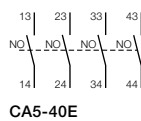

CA5-40E

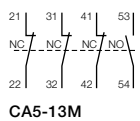

CA5-13M

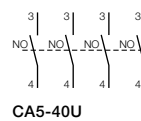

CA5-40U

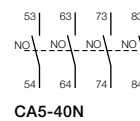

CA5-40N

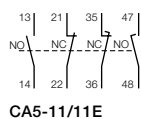

CA5-11/11E

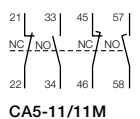

CA5-11/11M

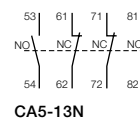

CA5-13N

# Electronic timers



TEF5-OFF

1SB0101386F0014

## Description

TEF5 frontal electronic timers are used for realizing timing function and are available in ON-delay and OFF-delay versions.

### Compact solution in cabinet compared to separate timers

TEF5 electronic timers are front-mounted and locked on A contactors or N contactor relays. A mechanical indicator allows to show the state of the contactor.

TEF5 electronic timers are supplied by direct wiring to the coil terminals A1 - A2 of the contactor or contactor relay. A varistor is integrated on the timer to offer a built-in protection against surges in the contactor coil.

### Available for a wide control voltage range 24...240 V AC / DC

TEF5-ON or TEF5-OFF allow time-delayed functions up to 100 s in 3 distinct time ranges, independently of the control system. The time delay ranges are selected by a switch and the time delay can be adjusted by means of a rotary switch. The timing function is activated by closing or opening the device on which the timer is mounted. The OFF-delay version operates without additional control supply.

## Ordering details

For contactors, contactor relays	Time delay range selected by switch	Delay type	Rated control circuit voltage U <sub>c</sub> V 50/60 Hz or DC	Auxiliary contacts 	Type	Order code	Weight Pkg (1 pce) kg
A9 ... A75 N	0.1...1 s 1...10 s 10...100 s	ON-delay	24...240	1 1	TEF5-ON	1SBN020312R1000	0.065
		OFF-delay	24...240	1 1	TEF5-OFF	1SBN020314R1000	0.065

# Electronic timers

## Technical data

3

### Contact utilization characteristics according to IEC

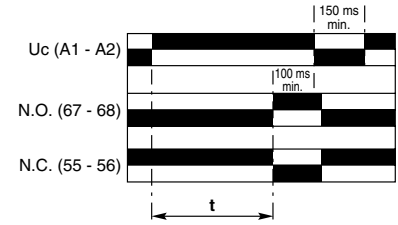
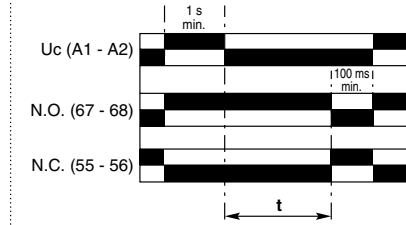
Types		TEF5-ON	TEF5-OFF
Standards		IEC 60947-5-1 and EN 60947-5-1	
Rated insulation voltage Ui acc. to IEC 60947-5-1		400 V	
Rated impulse withstand voltage Uimp		4 kV	
Rated operational voltage Ue max.		240 V	
Rated frequency (without derating)		50 / 60 Hz	
Conventional thermal current Ith - $\theta \leq 40\text{ }^\circ\text{C}$		5 A	
Ie / Rated operational current AC-15 acc. to IEC 60947-5-1		24-127 V 50/60 Hz 3 A	220-240 V 50/60 Hz 1.5 A
Making capacity		10 x Ie AC-15 acc. to IEC 60947-5-1	
Breaking capacity		10 x Ie AC-15 acc. to IEC 60947-5-1	
Ie / Rated operational current DC-13 acc. to IEC 60947-5-1		24 V DC 1 A / 24 W	
Short-circuit protection device gG type fuse		6 A	
Rated short-time withstand current Icw $\theta = 40\text{ }^\circ\text{C}$		for 1.0 s 8 A	for 0.1 s 8 A
Minimum switching capacity with failure rate acc. to IEC 60947-5-4		24 V DC 12 V / 3 mA	$10^{-7}$
Power dissipation per pole at 3 A		0.1 W	
Function diagram		ON-delay 	OFF-delay 
Bistable relay inside. Before use, once apply Uc then switch it off in order to initialize position of the contacts.			
Control circuit voltage			
AC control voltage	Rated control circuit voltage Uc 50/60 Hz	24...240 V AC	
	Average consumption	1.5 mA RMS	1 mA RMS
DC control voltage	Rated control circuit voltage Uc	24...240 V DC	
	Average consumption	1.5 mA	1 mA
Rated frequency limits		50 / 60 Hz	
Supply voltage range		0.85...1.1 x Uc (at $\theta \leq 70\text{ }^\circ\text{C}$ )	
Overvoltage protection		Varistor included	
Time delay range (t) selected by switch		0.1...1 s <input type="checkbox"/>	
		1...10 s <input type="checkbox"/>	
		10...100 s <input type="checkbox"/>	
On-load reiteration accuracy under constant conditions		$\leq 1\text{ }%$	
Minimum ON period		0.1 s	1 s
Recovery time		0.15 s	0.1 s
Ambient air temperature	Operation	-25 $^\circ\text{C}$ ... +70 $^\circ\text{C}$	
	Storage	-40 $^\circ\text{C}$ ... +80 $^\circ\text{C}$	
Climatic withstand		Category B according to IEC 60947-1 Annex Q	
Maximum operating altitude		2000 m	
Mounting positions		Acc. to mounting positions permitted on contactors or contactor relays	
Shock withstand acc. to IEC 60068-2-27 and EN 60068-2-27 (Mounting position 1)		1/2 sinusoidal shock for 11 ms: no change in contact position Same as contactor or contactor relay	
Mechanical durability			
	Number of operating cycles	5 millions operating cycles	
	Max. switching frequency	3600 cycles/h	1800 cycles/h
Max. electrical switching frequency			
	AC-15	1200 cycles/h	
	DC-13	900 cycles/h	



# Electronic timers





## Technical data

### Contact utilization characteristics according to UL / CSA

Types	TEF5-ON	TEF5-OFF
Standards	UL 508, CSA C22.2 N°14	
Rated insulation voltage Ui	300 V	
acc. to UL / CSA	240 V	
Max. operational voltage	B300, R300	
Pilot duty	5 A	
AC thermal rated current	3600 VA	
AC maximum volt-ampere making	360 VA	
AC maximum volt-ampere breaking	1 A	
DC thermal rated current	28 VA	
DC maximum volt-ampere making-breaking		

3

### Connecting characteristics

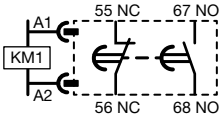
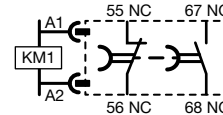
Connection capacity (min. ... max.)		
 Rigid solid	1 x	1...2.5 mm <sup>2</sup>
	2 x	1...2.5 mm <sup>2</sup>
 Flexible with non insulated ferrule	1 x	0.75...2.5 mm <sup>2</sup>
	2 x	0.75...2.5 mm <sup>2</sup>
 Flexible with insulated ferrule	1 x	0.75...2.5 mm <sup>2</sup>
	2 x	0.75...1.5 mm <sup>2</sup>
 Lugs	L ≤	8 mm
	L >	3.7 mm
Connection capacity acc. to UL / CSA	1 or 2 x	AWG 18...14
Stripping length		10 mm
Tightening torque		1 N.m / 9 lb.in
Degree of protection		
acc. to IEC 60947-1 / EN 60947-1 and IEC 60529 / EN 60529		IP20
Screw terminals		Delivered in open position, screws of unused terminals should be tightened
All terminals		M3.5
Screwdriver type		Flat Ø 5.5 / Pozidriv 2
Terminal Marking		
		

# Mechanical and electrical interlock units



1SBC580411F0301

VM300H

## Description

When mounted between two contactors, the mechanical interlock unit prevents one of the contactors from closing as long as the other contactor is closed.

- VM interlock units for mechanical interlocking of two horizontal or vertical mounted AC or DC operated contactors
- VE interlock units for mechanical and electrical interlocking of two horizontal mounted AC or DC operated contactors.

## Ordering details (1)

Left side contactor	Right side contactor	Mounting	Type	Order code	Pkg qty	Weight (1 pce) kg
---------------------	----------------------	----------	------	------------	---------	-------------------

### Mechanical interlock units for two horizontal mounted contactors (2)

A9 ... A40	A9 ... A40	Rail mounting or mounting plate to be ordered separately (3)	VM5-1	1SBN030100R1000	1	0.066
A9 ... A40	A45 ... A110	See table below with VE5 type	–	–	–	–
A45 ... A75	A45 ... A110	–	–	–	–	–
A95 ... A185	A45 ... A110	–	–	–	–	–
A95 ... A185	A145 ... A300	Additional plate (not supplied)	VM300H	1SFN034700R1000	1	0.150
A210 ... A300	A145 ... A300	–	VM300H	1SFN034700R1000	1	0.150

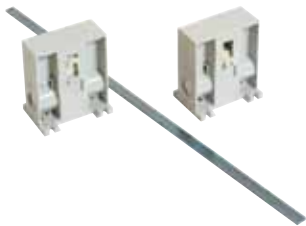

1SBC580411F0301

VM300V

Up contactor	Down contactor	Mounting	Type	Order code	Pkg qty	Weight (1 pce) kg
--------------	----------------	----------	------	------------	---------	-------------------

### Mechanical interlock units for two vertical mounted contactors (4)

A95 ... A185	A145 ... A300	Additional plate (not supplied)	VM300V	1SFN034701R1000	1	0.150
A210 ... A300	A145 ... A300	–	VM300V	1SFN034701R1000	1	0.150



1SBC572822F0301

VE5-1

Left side contactor	Right side contactor	Mounting	Type	Order code	Pkg qty	Weight (1 pce) kg
---------------------	----------------------	----------	------	------------	---------	-------------------

### Mechanical and electrical interlock units for two horizontal mounted contactors

A9 ... A40	A9 ... A40	Rail mounting or mounting plate to be ordered separately (3)	VE5-1	1SBN030110R1000	1	0.076
A30 ... A75	A45 ... A75	–	VE5-2	1SBN030210R1000	1	0.146
A45 ... A75	A30 ... A75	–	VE5-2	1SBN030210R1000	1	0.146
A45 ... A75	A95 ... A110	Additional plate (not supplied)	VE5-2 (5)	1SBN030210R1000	1	0.146
A95 ... A110	A45 ... A75	–	VE5-2 (5)	1SBN030210R1000	1	0.146
A95 ... A110	A95 ... A110	–	VE5-2	1SBN030210R1000	1	0.146

(1) For each contactor type, refer to "Accessory fitting details".

(2) Mechanical durability: VM5-1 = 5 millions cycles, VM300H = 1 million cycles.

(3) Rail mounting for: 2 x A9 ... A40 contactors only  
2 x A30, A40 contactors + MMS.

PM26-23 mounting plate for: 2 x A9 ... A26 contactors + MMS.

(4) Mechanical durability: VM300V = 1 million cycles.

(5) The combination of A45 ... A75 contactors interlocked with A95, A110 contactors cannot be mounted on symmetrical rail (75 mm, IEC/EN 60715).

# Mechanical and electrical interlock units

## Technical data

Types	VE5-1	VE5-2
-------	-------	-------



## Contact utilization characteristics according to IEC

Standards	IEC 60947-5-1 and EN 60947-5-1	
Rated insulation voltage $U_i$ acc. to IEC 60947-5-1	690 V	
Rated operational voltage $U_e$ max.	24...690 V	
Conventional thermal current $I_{th}$ - $\theta \leq 40$ °C	16 A	
le / Rated operational current AC-15 acc. to IEC 60947-5-1	24-127 V 50/60 Hz	6 A
	220-240 V 50/60 Hz	4 A
	380-440 V 50/60 Hz	3 A
	500-690 V 50/60 Hz	2 A
Making capacity	10 x $I_e$ AC-15 acc. to IEC 60947-5-1	
Breaking capacity	10 x $I_e$ AC-15 acc. to IEC 60947-5-1	
le / Rated operational current DC-13 acc. to IEC 60947-5-1	24 V DC	6 A
	48 V DC	2.8 A
	72 V DC	1 A
	125 V DC	0.55 A
	250 V DC	0.3 A
Short-circuit protection device - gG type fuse	10 A	
Rated short-time withstand current $I_{sw}$ $\theta = 40$ °C	for 1.0 s	100 A
	for 0.1 s	140 A
Power dissipation per pole at 6 A	0.15 W	
Mechanical durability	5 millions operating cycles	
Number of operating cycles	5 millions operating cycles	
Max. switching frequency	600 cycles/h	

## Utilization characteristics according to UL / CSA

Standards	UL 508, CSA C22.2 N°14
Max. operational voltage	600 V

## Connecting characteristics

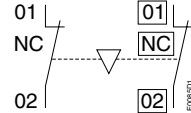
Connection capacity (min. ... max.)		
 Rigid solid	1 x	1...4 mm <sup>2</sup>
	2 x	1...4 mm <sup>2</sup>
 Flexible with ferrule	1 x	0.75...2.5 mm <sup>2</sup>
	2 x	0.75...2.5 mm <sup>2</sup>
 Lugs	L <	8 mm
	I >	3.5 mm
Tightening torque	Recommended	1 Nm
	Max.	1.2 Nm
Degree of protection acc. to IEC 60947-1 / EN 60947-1 and IEC 60529 / EN 60529	IP20	
Screw terminals All terminals	Delivered in open position, screws of unused terminals must be tightened M3.5	
Screwdriver type	Flat Ø 5.5 / Pozidriv 2	
Terminal marking		

Technical note: when, during switching, the arc time is estimated to more than 40 ms, the closing signal of one of the two contactors must be delayed with respect to the opening signal of the other contactor in order to prevent a short-circuit.

Use a TEF5 or TE5S electronic timer according to application use with time lapse for A contactors.

# Electronic timer for star-delta starters

3



TE5S...

## Description

When used in star-delta starters, the TE5S lags the star connection and provides a lapse of 50 ms before the switch over to delta connection.

According to the type of device chosen, the electronic circuit has a 24 V AC / DC, 110 to 120 V AC, 220 to 240 V AC or 380 to 440 V AC supply. An output relay with reversing contact ensures high current switching. A two-position switch allows selection of one of the two time delay ranges: 0.8 to 8 s or 6 to 60 s. The 0.1 to 1.0 graduated button allows an initial setting without steps within the previously selected range which can then be adjusted using a chronometer.

**Note:** We recommend that you allow for temperature drift for the final adjustment of the time delay setting. Drift: -0.2 % per °C.

For example, a setting made at 20 °C will yield a time delay shorter by 7 % at 55 °C in a cubicle (-0.2 % per °C i.e.  $-0.2 \times 35 = -7 \%$ ).

Regardless of these settings the TE5S provides a fixed "lapse" of 50 ms between the opening of contact 15-16 and the closing of contact 15-18. This time delay prevents from arc short-circuit during star to delta switching.

## Operation

On energization, the green U indicator light (voltage applied) comes on. Contact 15-16 then immediately moves to the closed position.

Count-down of the programmed time immediately commences. When the time delay has elapsed, contact 15-16 opens and at the same time the 50 ms lapse,  $t_2$ , begins after which contact 15-18 moves to the closed position. The yellow R indicator light comes on.

On de-energization, the U and R indicator lights go out and, after the 250 ms resetting time, the device is ready for a new cycle.

## Mounting

On 35 x 7.5 mm or 35 x 15 mm mounting rail according to IEC/EN 60715.

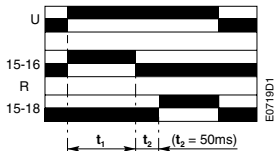

Chart

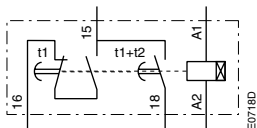

Equivalent diagram

## Ordering details

For contactors	Rated control circuit voltage		Type	Order code	Pkg qty	Weight (1 pce)
	V 50/60 Hz	V DC				
A9 ... A300	24	24	TE5S-24	1SBN020010R1001	1	0.080
	110...120	-	TE5S-120	1SBN020010R1002	1	0.080
	220...240	-	TE5S-240	1SBN020010R1003	1	0.080
	380...440	-	TE5S-440	1SBN020010R1004	1	0.080

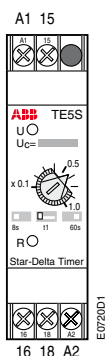

Front face

## Main dimensions mm, inches

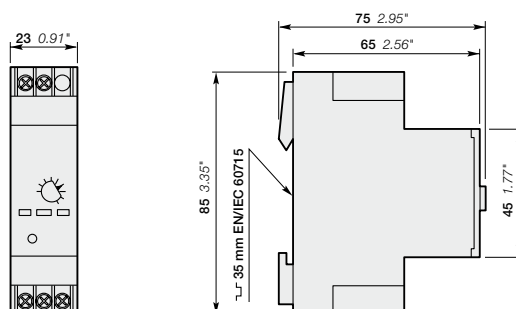



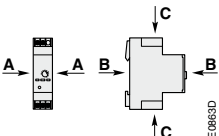

# Electronic timer for star-delta starters

## Technical data

Types	TE5S-24	TE5S-120	TE5S-240	TE5S-440	
<b>Utilization characteristics according to IEC</b>					
<b>Standards</b>	IEC 60947-5-1 and EN 60947-5-1				
<b>Rated insulation voltage Ui</b> acc. to IEC 60947-5-1	440 V				
<b>Rated operational voltage Ue max.</b>	24 V DC			–	
	24...240 V AC			440 V AC	
<b>Conventional free air thermal current Ith</b>	10 A				
<b>le / Rated operational current AC-15</b> acc. to IEC 60947-5-1	24-120 V 50/60 Hz	5 A		–	
	220-240 V 50/60 Hz	4 A		–	
	380-440 V 50/60 Hz	–		3 A	
<b>le / Rated operational current DC-13</b> acc. to IEC 60947-5-1	24 V DC	4 A		–	
<b>Short-circuit protection device - gG type fuse</b>					
<b>Control circuit voltage</b>					
<b>AC control voltage</b>	Rated supply voltage U <sub>c</sub>	24 V AC	110...120 V AC	220...240 V AC	380...440 V AC
	Average consumption	1.5 VA	3.5 VA	6.5 VA	12.5 VA
<b>DC control voltage</b>	Rated supply voltage U <sub>c</sub>	24 V DC	–	–	–
	Average consumption	0.7 W	–	–	–
	Rated frequency limits	48...63 Hz			
	Supply voltage range	0.85...1.1 x U <sub>c</sub>			
	Overvoltage protection	Built-in varistor			
	Load factor	100 %			
<b>Time delay range (t1) selected by switch</b>					
	Temperature drift	0.8...8 s and 6...60 s			
	Mechanical setting accuracy	-0.2 % per °C			
	On-load reiteration accuracy under constant conditions	±15 % of the setting range			
	On-load reiteration accuracy under constant conditions	±2 % after 1 million operating cycles			
<b>Minimum time lapse (t2)</b>					
	Minimum time lapse after 1 million of operating cycles	50 ms			
	Minimum time lapse after 1 million of operating cycles	40 ms			
<b>Resetting time (max.)</b>					
	Resetting time (max.)	250 ms			
<b>Front panel display</b>					
	green indicator light	Energization			
	yellow indicator light	Output relay activated			
<b>Ambient air temperature</b>					
	Operation	-25...+60 °C			
	Storage	-40...+85 °C			
<b>Shock withstand</b> acc. to IEC 60068-2-27 and EN 6006-2-27					
		<b>Shock direction</b>			
	A	20 g / 11 ms			
	B	15 g / 11 ms			
	C	20 g / 11 ms			
<b>Vibration withstand</b> acc. to IEC 60068-2-6 and EN 60068-2-6					
	Vibration withstand	10 to 300 Hz in the 3 directions			
	Mechanical durability	3 g			
	Mechanical durability	5 millions operating cycles			
	Electrical durability	1 million operating cycles			
	On-load maximum switching frequency	720 cycles/h		600 cycles/h	
<b>Fixing</b>					
	On rail according to IEC 60715, EN 60715	35 x 7.5 mm or 35 x 15 mm			

## Connecting characteristics

<b>Connection capacity (min. ... max.)</b>				
	Rigid solid	1 x	1...2.5 mm <sup>2</sup>	
	Flexible with ferrule	2 x	1...2.5 mm <sup>2</sup>	
		1 x	0.75...2.5 mm <sup>2</sup>	
		2 x	0.75...2.5 mm <sup>2</sup>	
<b>Tightening torque</b>	Recommended	0.6 Nm		
	Max.	0.8 Nm		
<b>Degree of protection</b> acc. to IEC 60947-1 / EN 60947-1 and IEC 60529 / EN 60529				
	Degree of protection	IP20		
<b>Screw terminals</b>				
	All terminals	Delivered in open position, screws of unused terminals must be tightened		
	Screw terminals	M2.5		
<b>Screwdriver type</b>				
	Screwdriver type	Flat Ø 4 / Pozidriv 1		

# Surge suppressors for contactor coils

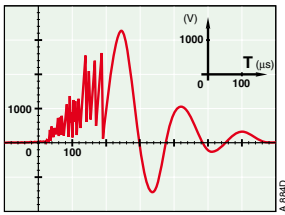

## Description

The operation of inductive circuits causes overvoltages, in particular on opening of the contactor coil.

The electromagnetic energy stored in the coil during contactor closing is restored on opening in the form of surges, the slope and amplitude of which may rise to several kilovolts. A number of drawbacks are observed ranging from interference on the electronic devices to breakdown of insulators and even destruction of certain sensitive components.

The graph opposite reproduces the oscillogram showing voltage discharges at the terminals of a 42 V / 50 Hz coil without peak clipping. The coil was switched by 8 series-connected poles of a contactor relay.

Following a burst of discharges with a very steep slope a damped oscillation emerges with a peak value of 3500 V.

### Overvoltage Factor

The overvoltage factor  $k$  is defined as the ratio of the maximum overvoltage peak value  $\hat{U}_s$  to the peak value  $\hat{U}_c$  of the coil rated control voltage  $U_c$ :

$$k = \frac{\hat{U}_s \text{ max.}}{\hat{U}_c} \quad \text{in DC: } k = \frac{\hat{U}_s \text{ max.}}{U_c} \quad \text{or in AC: } k = \frac{\hat{U}_s \text{ max.}}{U_c \sqrt{2}}$$

For example the following is obtained for the above graph:  $k = \frac{3500}{42 \sqrt{2}} \approx 60$

To reduce the harmful effects of these overvoltages, ABB has developed a range of surge suppressors designed to reduce the  $k$  factor defined above and to limit or even completely eliminate the high pre-damping voltage frequencies.

Each case is different, but the technical data tolerances and the generous sizing of parts have enabled us to reduce the number of variants.

We have chosen the following solutions: transient diodes, varistors and RC blocks.

Note: A varistor is a resistor whose value decreases to a very large extent when a certain voltage is applied at its terminals.



RV5/50

1SBC574001FC001



RC5-1/50

1SBC573891FC001

## Ordering details

For contactors	Rated control circuit voltage $U_c$		Type	Order code	Pkg qty	Weight (1 pce) kg
	V	AC DC				
A9 ... A110	24...50	● ●	RV5/50	1SBN050010R1000	2	0.015
	50...133	● ●	RV5/133	1SBN050010R1001	2	0.015
	110...250	● ●	RV5/250	1SBN050010R1002	2	0.015
	250...440	● ●	RV5/440	1SBN050010R1003	2	0.015
A9 ... A40	24...50	● -	RC5-1/50	1SBN050100R1000	2	0.012
	50...133	● -	RC5-1/133	1SBN050100R1001	2	0.012
	110...250	● -	RC5-1/250	1SBN050100R1002	2	0.012
	250...440	● -	RC5-1/440	1SBN050100R1003	2	0.012
A45 ... A110	24...50	● -	RC5-2/50	1SBN050200R1000	2	0.015
	50...133	● -	RC5-2/133	1SBN050200R1001	2	0.015
	110...250	● -	RC5-2/250	1SBN050200R1002	2	0.015
	250...440	● -	RC5-2/440	1SBN050200R1003	2	0.015
A145 ... A300	250...440	● -	RC5-3/440	1SBN050300R1003	2	0.028

# Surge suppressors for contactor coils

## Technical data

Varistor	RV5/50	RV5/133	RV5/250	RV5/440
Rated control circuit voltage U <sub>c</sub>	24...50 V AC 24...50 V DC	50...133 V AC 50...133 V DC	110...250 V AC 110...250 V DC	250...440 V AC 250...440 V DC
Residual overvoltage (clipping voltage)	132 V AC 132 V DC	270 V AC 270 V DC	480 V AC 480 V DC	825 V AC 825 V DC
Opening time growth factor	1.1...1.5			
Operating temperature	-20...+70 °C			
Connection to the coil terminals (parallel mounting)	Clip-on for both fixing and connection.			
Fixing	Clipped onto the top part of the contactor base without change in contactor overall dimensions.			
Advantages	High energy absorption: good damping - Unpolarized system.			
Drawback	Clipping as from U <sub>vdr</sub> (1), thus voltage front up to this point.			

(1) U<sub>vdr</sub> = Varistor operating voltage (voltage dependent resistor), tolerance ±10 %.

RC type	RC5-1/50	RC5-1/133	RC5-1/250	RC5-1/440
	RC5-2/50	RC5-2/133	RC5-2/250	RC5-2/440
	-	-	-	RC5-3/440
Rated control circuit voltage U <sub>c</sub>	24...50 V AC	50...133 V AC	110...250 V AC	250...440 V AC
Residual overvoltage (clipping voltage)	2 to 3 x U <sub>c</sub> max.			
Opening time growth factor	1.2...1.3			
Operating temperature	-20...+70 °C			
Connection to the coil terminals (parallel mounting)	Clip-on for both fixing and connection.			
Fixing	Clipped onto the top part of the contactor base without change in contactor overall dimensions.			
Advantages	Very fast clipping - Attenuation of steep fronts and thus of high frequencies. No operating delays.			

## Wiring diagrams

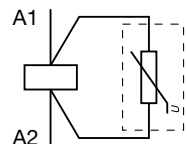

Varistor

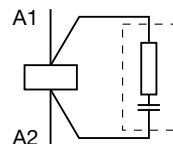

RC type

## Dimensions

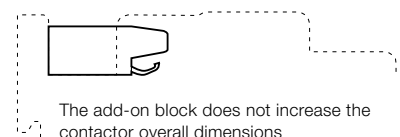

RV5, RC5

# Interface relays



3

RA5-1

## Description

RA5-1 interface relay is designed to receive 24 V DC signals delivered by PLC's or other sources with a low output power and to restore them with sufficient power to operate the coils of the relevant A9 ... A110 contactors.

RA5-1 interface relay is made up of a miniature electromechanical relay equipped with a N.O. contact and with a low consumption 24 V DC coil.

The interface relay coil is controlled by the PLC while the N.O. contact ensures switching of the power contactor.

Coil switching gives rise to overvoltages which have adverse effects on the electronic devices, insulators and, more generally, on component lifetime. The RA5-1 is equipped with surge suppressors:

- on the 24 V DC relay coil via a diode,
- on the power contactor coil via a varistor.

Furthermore, the RA5-1 is protected against relay pole reversal by a diode inserted between the E1 and E2 input terminals.

## Ordering details

For contactors	Coil voltages	Rated control circuit voltage Uc	Type	Order code	Pkg qty	Weight (1 pce)
	V 50/60 Hz	V DC				kg
A9 ... A110	24...250	24	RA5-1	1SBN060300R1000	1	0.050
			RA5-1	1SBN060300T1000	10	0.050





# Interface relays

## Technical data

Type	RA5-1
<b>Utilization characteristics according to IEC</b>	
Standards	IEC 60255-5
Rated insulation voltage $U_i$ acc. to IEC 60947-4-1	250 V AC
Ambient air temperature	
In free air operation	at $U_c = 24$ V DC (between E1 and E2) from 0.85 to 1.1 x $U_c$
Storage	
-25...+70 °C	
-25...+55 °C	
-40...+70 °C	
Climatic withstand	Complies with that of associated contactors
Maximum operating altitude	3000 m
Mounting positions	No limitation
Fixing	Using the contactor A1 and A2 terminal connecting parts

## Connecting characteristics

Connection capacity (min. ... max.)		
 Rigid solid	1 x	1...4 mm <sup>2</sup>
	2 x	1...4 mm <sup>2</sup>
 Flexible with ferrule	1 x	0.75...2.5 mm <sup>2</sup>
	2 x	0.75...2.5 mm <sup>2</sup>
 Lugs	L <	8 mm
	L >	3.5 mm
Tightening torque	Recommended	1 Nm
	Max.	1.2 Nm
Degree of protection	Protection against direct contact in acc. with EN 50274	
acc. to IEC 60947-1 / EN 60947-1 and IEC 60529 / EN 60529	RA5-1 wired and mounted on the associated contactor	
Screw terminals	Delivered in open position, screws of unused terminals must be tightened	
All terminals	M3.5	
Screwdriver type	Flat Ø 5.5 / Pozidriv 2	

## Working data

Surge suppression		
For contactor coil	Varistor	
For interface relay coil	Diode	
Protection against polarity reversal between terminals E1 and E2	Diode	
Interface relay operating time	Closing and drop-out ≤ 10 ms	
Total operating time, interface relay + contactor		
Between energization and:	N.O. contact closing	20...37 ms
	N.C. contact opening	17...32 ms
Between de-energization and:	N.O. contact opening	17...25 ms
	N.C. contact closing	20...28 ms

## Electrical input data

Control voltage (E1 and E2 terminals) $U_c$		
Rated value	24 V DC	
Max. range at ambient temperature 20 °C	19...30 V DC	
Max. consumption for $U_c = 24$ V DC, $\theta = 20$ °C	0.3 W	
"0" status (relay open)	for $U_c$	≤ 2.4 V DC
	for $I_c$	< 1 mA
"1" status (relay closed)	for $U_c$	≥ 19 V DC
Max. short supply interruption immunity time	2 ms	

## Electrical output data

Switching voltage (A0 and A2 terminals)	≤ 250 V AC
Electrical durability	
Number of operating cycles	2 millions (600 cycles/h) on A9 ... A75 contactors or N contactor relays 0.5 million (600 cycles/h) on A95 and A110 contactors

## Connection

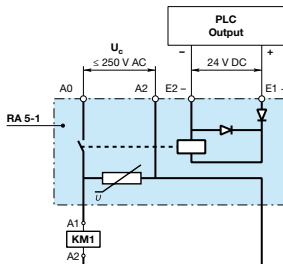
	<p>The "E1+" and "E2-" input terminals must be connected, according to their polarity, to the PLC output. The RA5-1 is equipped with two terminal pads for connection to the A1 and the A2 terminals of the contactor coil.</p> <p>This coil is supplied between the A0 and the A2 terminals of the RA 5-1.</p> <p>Mounting: terminals pads clamped inside the contactor coil terminals.</p>
---	--

# Mechanical latching units



1SBC66483F0301

WB75-A

3

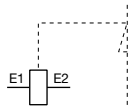

Terminal marking

## Description

For converting standard contactors into latched contactors.

The WB75-A block contains a mechanical latching device with electromagnetic impulse unlatching (AC or DC) or manual unlatching.

Captive screw type connecting terminals, built-in cable clamps, M3.5 (+,-) pozidriv 2 screw with screwdriver guidance; delivered untightened and protected against accidental direct contact.

## Operation

After closing, the contactor continues to be held in the closed position by the latching mechanism should the supply voltage fail at the contactor coil terminals.

Contactor opening can be controlled:

- electrically by an impulse (AC or DC) on the WB75-A block coil.  
(the coil is not designed to be permanently energized)
- manually by pressing the pushbutton on the front face of the WB75-A block.

## Mounting

The WB75-A block is clipped onto the front face of the 1-stack contactor where it takes up two slots. The two other slots may accept CA5... single pole auxiliary contacts (1 block on each side of the mechanical latch).

## Ordering details

For contactors	Rated control circuit voltage U <sub>c</sub>		Type	Order code	Pkg qty	Weight (1 pce) kg
	V 50 Hz or DC	V 60 Hz				
A9 ... A75	24	24...28	WB75-A	FPTN372726R1001	1	0.120
	42	42...48	WB75-A	FPTN372726R1002	1	0.120
	48	48...55	WB75-A	FPTN372726R1003	1	0.120
	110	110...127	WB75-A	FPTN372726R1004	1	0.120
	220...230	220...255	WB75-A	FPTN372726R1006	1	0.120
	230...240	230...277	WB75-A	FPTN372726R1005	1	0.120
	380...415	380...440	WB75-A	FPTN372726R1007	1	0.120
	415...440	440...480	WB75-A	FPTN372726R1008	1	0.120

# Mechanical latching units



## Technical data

Type	WB75-A
------	--------

## Utilization characteristics according to IEC

Rated insulation voltage $U_i$ acc. to IEC 60947-1	690 V
<b>Max. electrical impulse time</b>	
On AC coil (with load factor 5 %)	20 s
On DC coil (with load factor 3 %)	8 s
<b>Min. electrical impulse time</b>	
For latching (energizing of the contactor coil) <b>AC</b>	50 ms
For pull-out (energizing of the WB block coil) <b>AC</b>	30 ms
<b>Coil operating limits</b> <b>AC or DC supply</b>	0.85...1.1 x $U_c$
<b>AC control voltage</b> 50/60 Hz	
Rated control circuit voltage $U_c$	24...480 V AC
Coil consumption	<b>Average pull-in value</b> 90 VA
	<b>Average holding value</b> 60 VA
<b>DC control voltage</b>	
Rated control circuit voltage $U_c$	24...440 V DC
Coil consumption	<b>Average pull-in value</b> 110 W
	<b>Average holding value</b> 110 W
<b>Operating time</b>	
On contactor closing (latching)	
Between coil energization and:	
<b>N.O. contact closing</b>	No difference with the operation of a contactor without mechanical latching unit
<b>N.C. contact opening</b>	No difference with the operation of a contactor without mechanical latching unit
On contactor opening (unlatching)	
Between WB coil energization and:	
<b>N.O. contact opening</b>	5...25 ms
<b>N.C. contact closing</b>	7...28 ms
<b>Mechanical durability</b>	
<b>Number of operating cycles</b>	1 million operating cycles
<b>Max. switching frequency</b>	3600 cycles/h with on-load factor of 8 %

## Connecting characteristics

<b>Connection capacity</b> (min. ... max.)		
 Rigid solid	<b>1 x</b>	1...4 mm <sup>2</sup>
	<b>2 x</b>	1...4 mm <sup>2</sup>
 Flexible with ferrule	<b>1 x</b>	0.75...2.5 mm <sup>2</sup>
	<b>2 x</b>	0.75...2.5 mm <sup>2</sup>
 Lugs	<b>L &lt;</b>	8 mm
	<b>I &gt;</b>	3.5 mm
Tightening torque	Recommended	1 Nm
	Max.	1.2 Nm
<b>Screw terminals</b>	Delivered in open position, screws of unused terminals must be tightened	
All terminals	M3.5	
<b>Screwdriver type</b>	Flat Ø 5.5 / Pozidriv 2	

# Function markers

## Impulse contact blocks

3



BA5-50

1SBC574974FC001

### BA5-50 function markers

#### Description

Set of 50 function markers designed to be clipped onto the front face of devices. Details can be added to these markers using a ball point pen, indelible felt-tip pen or pentel white.

Self-adhesive labels (not supplied) can also be added to them.

Marker dimensions: 7 x 19 mm (0.276" x 0.748").

#### Ordering details

For contactors	Type	Order code	Pkg qty	Weight (1 pce)
Contactors, thermal overload relays and accessories	BA5-50	1SBN110000R1000	1	0.017 kg

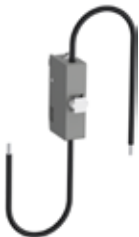

CB5

1SBC100039A0014

### CB5 impulse contact blocks

#### Description

Impulse contact blocks are designed for use in enclosures, in association with an adjustable mechanical pushbutton. Two types are available:

- CB5-10: N.O. contact with a black actuator ("ON" function)
- CB5-01: N.C. contact with a light grey actuator ("OFF" function).

These blocks are equipped with 2 connecting leads 0.5 mm<sup>2</sup> with end, approximately 18 cm long.

Mounting: Clipped onto the front face of the contactors.

#### Ordering details

For contactors	Contacts	Type	Order code	Pkg qty	Weight (1 pce)
					kg
A9 ... A110	1 -	CB5-10	1SBN010013R1010	1	0.012
	- 1	CB5-01	1SBN010013R1001	1	0.012

#### Main dimensions mm, inches

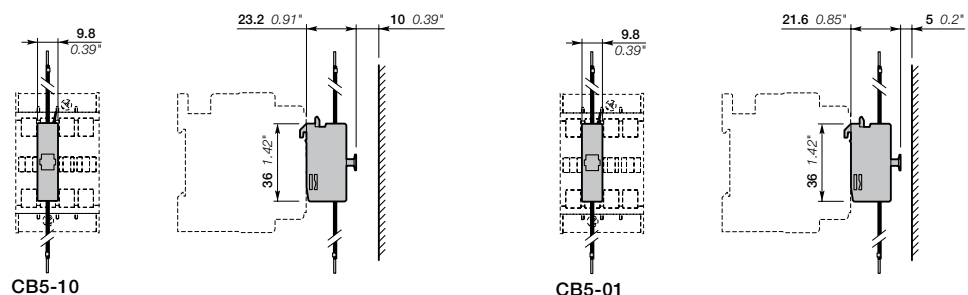

CB5-10

CB5-01

1SBC101898S0201

# Terminal shrouds, terminal enlargements, terminal extensions

## Connector terminals



LT...-AC

1SFT98099-019C3



LT...-AL

1SFT98099-125



LT...-AY

1SFT98000-014



LW...

1SFT98000-011C3



LX...

1SFT98000-012C3



LZ...

1SFT98099-00211C1



LZ...

1SFT98099-096C2



LZ...

1SBC580642F0302

## Terminal shrouds

### Description

Main terminal protection for A145 ... A300 contactors.

The auxiliary contact blocks and coils are designed to provide an IP20 degree of protection.

The main terminals, equipped with lugs or connectors, can be protected against accidental direct contact after wiring (EN 50274) by the addition of terminal shrouds (see table below).

### Ordering details

For contactors	Type	Order code	Pkg qty	Weight (1 pce) kg
A145 ... A185 with connectors	LT185-AC	1SFN124701R1000	2	0.050
A145 ... A185 with lugs	LT185-AL	1SFN124703R1000	2	0.220
A145 ... A185 with short. bar LY185 or between A145 and TA200DU or between A185 and TA200DU	LT185-AY	1SFN124704R1000	1	0.050
A210 ... A300 with connectors	LT300-AC	1SFN125101R1000	2	0.070
A210 ... A300 with lugs	LT300-AL	1SFN125103R1000	2	0.280
A210 ... A300 with short. bar LY300	LT300-AY	1SFN125104R1000	1	0.075

## LW... Terminal enlargements

### Description

Enlargement pieces designed to increase the width of the contactor terminal pads in order to allow larger connections to be mounted.

Sets containing 3 tin plated copper bars fixed by an isolating spacer.

### Ordering details

For contactors	Dimensions		Type	Order code	Pkg qty	Weight (1 pce) kg
	hole Ø mm	bar mm				
A95, A110	6.5	15 x 3	LW110	1SFN074307R1000	1	0.100
A145, A185	10.5	20 x 5	LW185	1SFN074707R1000	1	0.250
A210 ... A300	10.5	25 x 5	LW300	1SFN075107R1000	1	0.450

## LX... Terminal extension

### Description

Extension pieces designed to extend the main terminals of contactors for combined mounting of contactors and connection sets.

Sets containing 3 tin plated copper bars fixed by an isolating spacer.

### Ordering details

For contactors	Dimensions		Type	Order code	Pkg qty	Weight (1 pce) kg
	hole Ø mm	bar mm				
A145, A185	8.5	20 x 5	LX185	1SFN074710R1000	1	0.250
A210 ... A300	10.5	20 x 5	LX300	1SFN075110R1000	1	0.350

## Connector terminals

### Description

Connection of copper and aluminium cables to the terminal pads of the poles of A contactors.

### Ordering details

Cables	For contactors	Cable cross section	Type	Order code	Pkg qty	Weight (1 pce) kg
		mm <sup>2</sup>				
Single Cu	A145, A185	6...185	-	1SDA023354R0001	3	0.200
	A210 ... A300	16...240	-	1SDA023368R0001	3	0.400
Single Al & Cu	A145, A185	35...95	-	1SDA023356R0001	3	0.100
	A145, A185	25...150	-	1SDA023357R0001	3	0.100
	A210 ... A300	120...240	-	1SDA023370R0001	3	0.200
	A145, A185	2 x (50...120)	LZ185-2C/120	1SFN074709R1000	3	0.300
Double Al & Cu	A210 ... A300	2 x (95...120)	-	1SDA025766R0001	3	0.400

# Voltage code table

The below tables indicate the available coil voltages and corresponding digits for order codes. When placing an order, please give the order code. Select a standard contactor from ordering detail pages. Change the **coil voltage code** in the order code according to the table below. Example: for contactor A50-30-00 and coil 48 V 50/60 Hz, the order code is 1SBL351001R**83**00.

## A contactors

3

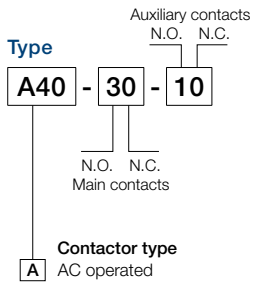

Order code

**1SBL321001R 80 10**

AC coil code  
Contactors: A

	50 Hz	60 Hz
<b>81</b>	24 V	24 V
<b>82</b>	42 V	42 V
<b>83</b>	48 V	48 V
<b>84</b>	110 V	110...120 V
36	190 V	220 V
<b>80</b>	<b>220...230 V</b>	<b>230...240 V</b>
<b>88</b>	230...240 V	240...260 V
<b>85</b>	380...400 V	400...415 V
<b>86</b>	400...415 V	415...440 V

Codes in bold for dual frequency coils.

## N contactor relays

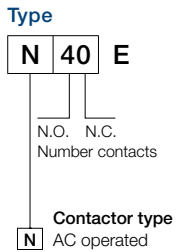

Order code

**1SBH141001R 80 40**

AC coil code  
Contactors: A

	50 Hz	60 Hz
<b>81</b>	24 V	24 V
<b>82</b>	42 V	42 V
<b>83</b>	48 V	48 V
<b>84</b>	110 V	110...120 V
36	190 V	220 V
<b>80</b>	<b>220...230 V</b>	<b>230...240 V</b>
<b>88</b>	230...240 V	240...260 V
<b>85</b>	380...400 V	400...415 V
<b>86</b>	400...415 V	415...440 V

Codes in bold for dual frequency coils.